

HERE'S WHAT YOU MISSED

In October, the EPFG held meetings in Everett and Spokane Washington. The Eastern Washington meeting was on Oct 5th. Our president Paul Knoop, went to Spokane to facilitate the meeting on glass matting. There were 9 frame shops represented, with several folks traveling over 100 miles to attend. Three non-member shops believe in the work of the EPFG, and joined as new members. There was a lot of enthusiasm, and it was great to meet some new folks.

The Everett meeting was held at Anabel's Framing on October 13th. Our hostess, Helen Kane, led the evening discussion on getting ready for the holidays. There were a number of great ideas for Christmas merchandising, starting with the planning process, decorating, window displays, and gift ideas. Participants shared strategies for handling rush orders, organizing work, and ways to deal with the all too familiar "out of stock" problem. Sales reps made suggestions to help retailers cope with the holiday crush and to insure fewer problems with deliveries. Throughout the evening, there were many times that retailers and vendors spoke about the importance of helping each other out and of sharing information with each other. This was a great meeting and you missed out if you weren't there.

NEXT MEETING

TUESDAY, NOVEMBER 10TH
 COLORPLAK®
 REDMOND, WASHINGTON
 7 PM SOCIAL
 7:30 MEETING
 "NIGHTMARE ON FRAME STREET"

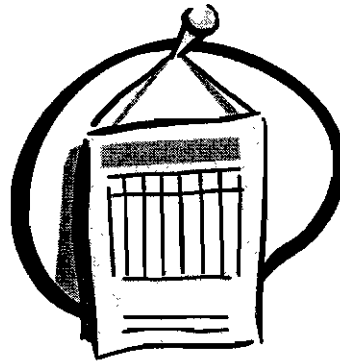

EPFG will provide a cash prize of \$50.00 for the BEST, or is it the WORST Nightmare on Framestreet to be told during the evening. Come prepared with your tale of horror; we will all have a good time and hopefully a great attendance with lots of participation, as there is no one out there without something to tell. But, only true stories, please.

INSIDE THIS ISSUE

TOP 10 REASONS TO ATTEND AN EPFG MEETING	ALL PAGES
PRESIDENT'S LETTER	3
CAN YOU BELIEVE THIS?	6
EPFG UPCOMING EVENTS & NOTICES	BACK



November 1998

Newsletter Cost: free to EPFG members, \$1.00 for non-members

EPFG on the Web
www.myframeshop.com/epfg/members/

Serving Alaska & Washington

TOP 10 REASONS TO ATTEND AN EPFG MEETING

TO LEARN ABOUT NEW PRODUCTS AND TECHNIQUES AND TO CONTINUE TO EDUCATE YOURSELF ABOUT YOUR PROFESSION.

9 10

TO INTERACT ON A REGULAR BASIS WITH OTHER RETAILERS AND VENDORS AND TO CREATE A COMMON GROUND FOR THE BETTERMENT OF THE INDUSTRY.



NATIONAL GLASS

17030 WOODINVILLE-REDMOND ROAD, WOODINVILLE, WA. 98072

QUALITY PRODUCTS AND EXCELLENT SERVICE! NATIONAL GLASS INVENTORIES THE LARGEST SELECTION OF PICTURE FRAMING GLASS IN THE PACIFIC NORTHWEST.



NATIONAL GLASS

TRU VUE AND SANDEL PREMIUM, REFLECTION CONTROL, SATINVIEW, CONSERVATION SERIES GLASS, IMAGE PERFECT, DENGLAS, AND CRYSTALVIEW.

Now Available - AR Glass & Museum Glass!

ALSO AVAILABLE: *FOAM-X*, MIRROR AND ACRYLICS

EVERYTHING YOU NEED AND *FREE DELIVERY* ARE ONLY A PHONE CALL AWAY!

(425) 488-8126

1 (800) 521-7061

fax (425) 488-3712



HOW TO CONTACT US

Membership Dues, Advertising Payments, Change of Address:

Paul Miller, EPFG Treasurer
4614 - 180th Place SW
Lynnwood, WA 98037
425-771-9519

Classified Ad copy, Display Ad copy, Article Suggestions:

Tim Taricco
P.O. Box 411
Redmond, WA 98073
taricco@myframeshop.com

For changes of address please include old and new address information.

Non-members must include \$10 for each Classified Ad.

General Questions:

Contact information for the EPFG Officers and Board of Directors can be found on the back of this newsletter.

Deadlines:

This newsletter is published monthly on the 25th prior to the month of distribution.

Online:

<http://www.myframeshop.com/epfg/members/>

Join Today:

Return the application on page 9 along with \$40 to become a member of EPFG

MAT MAESTRO

1150 Industry Drive Tukwila, WA 98188



Revolutionary high speed computerized mat cutter. Expand your product lines to include creative, low cost production mats...see improvements in profitability. Purchase or finance/lease for as little as \$382/mo.

A Division of RCI, Inc.
Suppliers to the Picture Framing Industry for over
30 years

206.575.2727 Fax: 206.575.2667

The EPFG Newsletter and Internet Web Site are published monthly by Tim Taricco. **Mailing Address:** P. O. Box 411 - Redmond, Washington 98073-0411. **Phone:** (425) 885-9730 **E-mail:** taricco@myframeshop.com **Web Site:** <http://www.myframeshop.com/tradeonly/>. **Comments and suggestions** about the EPFG Newsletter and Internet Web Site should be made to Tim Taricco. Newsletter Design © 1998 T. M. Taricco and Newsletter Content © 1998 Evergreen Picture Framers Guild. All rights reserved. Do not duplicate or redistribute in any form.



Jeff Schuffman
Sales Representative

1433 W. Frankford Rd. #100 Carrollton, Texas 75007
972-466-0721 • 972-466-3662 Fax
800-527-0421 • 800-817-0524 Fax
Ext. 882



Wholesale Picture
Frame Supplies

2928 4th Ave S • Seattle, WA 98134
206-292-9664
800-423-6287

PRESIDENT'S LETTER



First, a quick update on my trip to Eastern Washington for a Guild meeting on Oct 5th. It was great! There were 9 frame shops represented, with several folks traveling over 100 miles to attend. Three shops believe in what we are trying to do, and joined as new members. There was a lot of enthusiasm, and it was great to meet some new folks and, as I mentioned last month, learn a new trick; that of using a wood burning tool to cut the Contact Paper TM stencils for use in working on glass mats with etching cream or sandblasting. It sure seems easier than cutting with a blade, at least on curves. You can be assured we will return to the "dry side" for more meetings next year.

On the subject of meetings, the Board hopes to have a planning calendar for the meeting location and topics for the year published with the January newsletter, so if you can host a meeting or have a subject that would work for a meeting, let one of us know. Several months are already spoken for, but don't let that hold you back.

At the last Board meeting, we discussed the results of the
(Continued on page 5)

TO KEEP
INFORMED ABOUT
INDUSTRY ISSUES
AND TO MAKE
YOUR VOICE
HEARD BOTH ON
THE LOCAL AND
NATIONAL LEVEL.

8

TO "GIVE BACK"
SOME OF WHAT
YOU HAVE
LEARNED
BECAUSE OTHERS
IN THE EPFG
WERE WILLING TO
SHARE THEIR
KNOWLEDGE FOR

7

TRUVUE GLASS
FOR EVERY FRAMING NEED

<p>PREMIUM SERIES GLASS</p> <ul style="list-style-type: none"> • PREMIUM CLEAR® • REFLECTION CONTROL™ • AR® REFLECTIVE FREE 	<p>CONSERVATION SERIES GLASS</p> <ul style="list-style-type: none"> • CONSERVATION CLEAR® • CONSERVATION REFLECTION CONTROL™ • MUSEUM GLASS™
-------------------------------------------------------------------------------------------------------------------------------------------------------------------------	------------------------------------------------------------------------------------------------------------------------------------------------------------------------------------------

1-800-368-3688
www.truveuglass.com

Colorplak®

Beautiful - Durable - Affordable Framing Alternative

17830 NE 65th Street
Redmond, WA 98052

800-305-1953

Our Local
Sales Representative

Tim Taricco
425-885-9730

New Pre-Covered Lip Liner

Ask about our
Distributors Discount.

Expanded Liner Selection

Framing Fabrics & Moulding International

is very happy to introduce NEW LINERS. With the recent expansion of our liner offerings, we are able to provide our customers with a complete liner selection, at very competitive prices. These seven new additions include a flat profile in two sizes, a bevel profile in two sizes and a scoop profile in three sizes, all with hand-finished lips of bright gold, antique gold and antique silver. These lip liners are available in four fabrics, 100% BELGIQUE Natural Linen; Union Blend of MANHASSET Natural and Oyster and Antique Satin MARQUIS Black.

LIP FINISHES

Bright Gold ❖ Antique Gold ❖ Antique Silver

FABRICS

Manhasset Natural ❖ Manhasset Oyster
Belgique Natural ❖ Marquis Black

All are pre-covered. However, we are also able to meet most of your custom needs (*Custom Wraps*), just call and ask our Customer Service Department personnel. Upon request, we can cover our lip liners with any of the 500 fabrics we sell. A 50 ft. minimum applies to liners cut to 6 & 4 or 5 & 5 ft. lengths; a 100 ft. is required on liners in standard 10 ft. lengths.

These liners are in addition to the original thirty liner profiles we offer in Primed, Pre-covered and *Custom Wrapped* both in length and chop.

FLAT

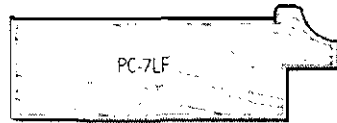
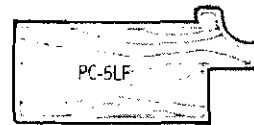

BEVEL

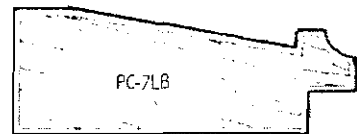
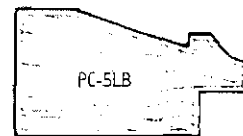

SCOOP

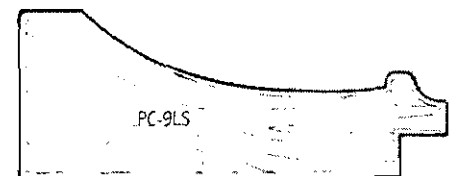
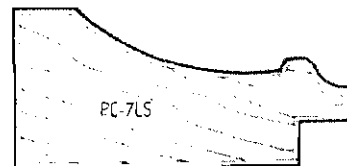
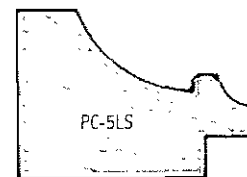

Shown Actual Size



PRESIDENT'S LETTER CONTINUED

(Continued from page 3)

members' vote on the Bylaws, (approved) and adopted them effective Oct 1, 1998. Printed copies will be available at all future Guild meetings, and if you would like a copy but are unable to attend, let me know and I will mail yours. We also discussed the upcoming election of two new Officers and Board members. Ballots should be in the mail soon, and a voice vote will be held at the January meeting. We can always use more volunteers to either elected positions or appointed to a committee e.g. to help with the Trade Show (see the article elsewhere and the Calendar on the back page).

With the year drawing to a close, I am beginning to look back over the progress our organization has made and all of the hard work that has made it possible. It is gratifying to be associated with such a group of professionals, and to know that I can count on them to get the job done. Every one has stepped up to the challenge of making things happen, and I am confident that next year will be even better, especially with the support of our members.

I would like to wish each of you a happy Thanksgiving, and hope that you are well on the way to a very profitable Holiday season. Thanks again for your support and help.

Paul Knoop
EPFG President

6

TO BUILD A BETTER EPFG
BY PARTICIPATING SO THAT
WE CAN CONTINUE TO
HAVE A LOCAL
ORGANIZATION TO SERVE
OUR NEEDS.

5

TO ENJOY SEEING THE
UNIQUE AND DIVERSE KINDS
OF BUSINESS
ESTABLISHMENTS THAT OUR
RETAIL AND VENDOR
MEMBERS HAVE CREATED.

Software Suite for Windows 95 and earlier
Galleries & Frame shops Networking User Friendly!

FERENSOFT
TRIO!

- Art
- Customers
- Framing

Point of Sale and Business Management
suite with optional WIZARD™ mat cutter link.
See why people are switching to FS TRIO!
Seattle 206-282-1775.

VICTOR
MOULDING COMPANY

Have You Seen?

Southern Comfort Line
Hunt Club Line
Impasto Line
Tiburon Line

IF YOU HAVEN'T, CALL YOUR SALES
REPRESENTATIVE TODAY!

1-800-359-2829

Chuck Bigford Ext. 3715

3439 S.W. BOND
PORTLAND, OREGON 97201

Jim Jillard - Branch Manager

STUDIO
MOULDING

8214-B South 192nd St., Kent, WA 98032

FREE FREIGHT

On all orders over \$100.00 in OR and WA

JOE HUBER

Orders: (800) 262-4174
Voice Mail Ext: 217
Fax: (888) 423-1814

HARTUNG GLASS INDUSTRIES

- ◆ Complete line of Acrylics; Clear, Non-Glare & UV.
- ◆ We carry Tru-View, Sandel & Crystalview
- ◆ Specializing in beveled mirrors for framing.
- ◆ Next day delivery from Everett to Tacoma.
- ◆ Over 20 years experience with picture framers.
- ◆ Call us and have a Customer Service Representative specializing in your needs help you.



17830 West Valley Highway, Seattle, WA 98188
(206)656-2626, (800)552-2227, FAX (206)656-2601

4

TO HAVE THE OPPORTUNITY TO SEE MORE OF OUR BEAUTIFUL NORTHWEST THAN JUST THE SCENERY YOU SEE EACH DAY DRIVING BACK AND FORTH TO WORK.

3

TO HAVE THE CHANCE TO GRUMBLE AND COMPLAIN TO PEOPLE WHO WOULD UNDERSTAND ABOUT THAT HORRIBLE CUSTOMER OR THAT HEADACHE OF A FRAME JOB YOU JUST SPENT 3 HOURS ON!

2

TO ENJOY FREE SNACKS, DRINKS, AND CONVERSATION.

CAN YOU BELIEVE THIS?

By Terry Scidmore - *The Mitered Corner* - Seattle, WA

Recently, I had a customer come in who wanted to know what it cost to have her picture framed. I worked with her a while on the framing design, and when I started adding the order so she would know what the framing would cost, she told me that she wasn't interested in what the framing would cost in my store. She wanted to know what the framing would cost "at the cheap framing place in the mall." A bit taken aback, I told her that I didn't know. I explained that I would be glad to let her know what it would cost in my store, but she would have to go to the other store to find out what their prices were. She responded that she was sure that she couldn't afford to have me frame her picture. She just came in to find out what the "really cheap store" would charge, and rather than drive "all the way to the mall" she figured that I could tell her. I again suggested that I show her what it would cost to frame the picture in my store, and I was sure that she would find the cost wasn't that exorbitant. "Oh, no, you don't have to do that. I don't want to spend much on the picture. I thought that if you would tell me what it would cost at the other store, I could decide if I wanted to spend time and gas driving out to that really cheap shop at the mall. Since you can't, I guess that I won't get my picture framed."



Chances are you started out with a LOGAN Mat Cutter Have you seen what we've done lately?

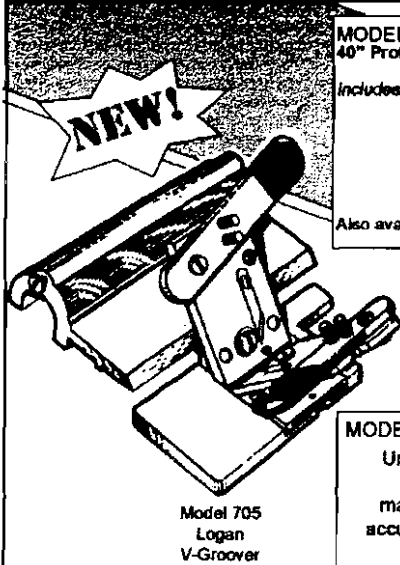

Model 705
Logan
V-Groover

MODEL #650 *Framer's Edge* MAT CUTTER 40" Professional Production Matcutter

- Includes:
- Ergonomically designed Dual straight and Bevel cutting head
 - Production Stops
 - Parallel Mat Guide
 - Start and Stop Indicator for line to line cutting.
 - 27" Squaring Arm

Suggested List Price \$599.95

Also available in a 60" version MODEL #680 *Framer's Edge* \$799.95

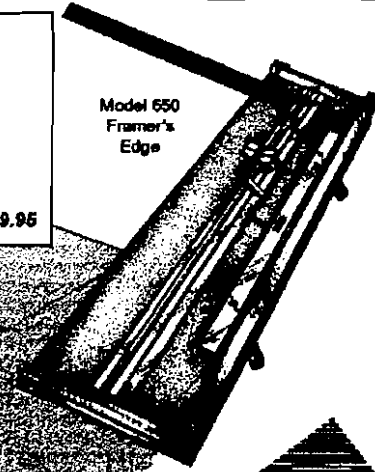

Model 650
Framer's
Edge

MODEL 705 LOGAN V-Groover ^{patented}

Unique "push-pull" surface V-Groover that cuts beautiful V-Grooves on the surface of the matboard. Works entirely with stops provided for accurate V-Grooving in seconds with zero overcuts. Endless creative possibilities!!

Suggested List Price \$125.00

MODEL 706 Universal V-Groover ^{patented}

Works on professional mat cutters using a 5/8" thick cutting bar rod including Fletcher® and C&H® professional matcutters.

Suggested List Price \$150.00



GRAPHIC PRODUCTS, INC.

1100 BROWN STREET • WALCONDA, ILLINOIS 60084
NATIONWIDE TOLL FREE 1-800-733-4232
TOLL FREE FAX 800-371-6229

Website: <http://www.artproducts.com>

Email: Logan-Graphic-Products@worldnet.att.net

Need Training for New Employees?

**SEE WHAT YOUR DOLLAR
CAN DO IN CANADA**

The Canadian Picture Framer's School

#1, 20678 Duncan Way
Langley, B.C.

providing excellent thorough
instruction in picture framing for
over 10 years. Phone or fax
for more info:

Ph: 604-533-5328

Fax: 604-533-9680



FRAMERS' INVENTORY

NOW OPEN IN SEATTLE!

WOOD MOULDING

Arquati, Bay, Framers' Inventory,
LaMarche, Max, Roma, Williamson

METAL MOULDING

Nielsen

MATBOARD

Bainbridge, Crescent, Tru Vue

GLASS & FOAMBOARD

True Vue, Sandel,
Bientfang, Bainbridge

EQUIPMENT

C&H, Fletcher
Seal Mounting

SERVICE

Daily delivery in the
Portland & Seattle Metro areas
Will call open til 6:00 PM
Overnight chop service



4412 4TH AVENUE SOUTH, SEATTLE WA 98143
5000 SE 18TH AVENUE, PORTLAND, OREGON 97202
TOLL FREE(800)543-2467 FAX(503)238-3899



SEATTLE, WA 98133



THE ART DOCTOR

Restoration of Oil Paintings, Japanese Screens,
Art on Paper, Art Objects

NANCY G. WHITE
Restorer

(206) 783-9160
By Appointment

Williamson • TruVue Glass/Miller Matboard • Clark • Designer Wood & Metal
Piedmont • Colonial • Burnich • Frontone

INTRODUCING:
5 New Library Leather Matboards from Miller
plus 4 New Slate & Shagreen

Call for samples

METAL FRAMES ART



9610 EAST ALKI WAREHOUSE #5
PHONE 800 341-7329 509 335-3440

SPOKANE WASHINGTON 19212
FAX 800 344-5603 509 335-3466

PRADO

Seven golden mouldings reminiscent of regal antiquity.

For more information on Prado and other Larson-Juhl framing products call:
(216) 433-6002, (800) 627-1500 or (800) 438-5031

or contact your Larson-Juhl sales representative

Voice Mail: 800-223-0307

Stephen Dean - ext. 454 • Paul Anderson - ext. 456 • Joe Garitone - ext. 455

LARSON · JUHL

ADDING ARTISTRY TO ART
WARMTH TO LIVING

**Colorful, Creative,
Pure & Strong...**



Crescent Rag Mat
100% Cotton Museum Board

The choice of Artists & Picture Framing Professionals,
for archival and conservation matting.
Acid-free and lignin-free.

Send in your business card to receive
your FREE Rag Mat Booklet (RM-100).

Crescent Cardboard Company 100 W. Willow Road, Wheeling, IL 60090 U.S.A.



Pacific Framing Supply

"Serving all of your framing needs"

Brad Airhart & John Cave

Salem, OR 97304
Phone: 1-800-872-4445
FAX: 1-503-363-7273

Woodinville, WA 98072
Phone: 1-800-292-3202
FAX: 1-206-486-4978



NURRE CAXTON

FRAMES OF DISTINCTION



"We're Obsessed
With Customer
Satisfaction"

Pamela Neal

Sales Representative for
Washington, Wyoming, Montana
Oregon and Idaho

1-800-255-1942, press 6, ext. 4011
for voice mail
1-800-377-3300 fax
1-800-910-8966 pager

We promise friendly, reliable service,
same day chop service, free UPS
for orders of 3 chops or more
(wood and Nielsen metal combined)

1

AN THE #1 REASON TO ATTEND AN EPFG MEETING.....

TO HELP US BUILD A BETTER TOP 10 LIST.

Special thanks to Terry Scidmore for developing the top 10 list.

CLASSIFIED ADS

- **Looking for a Chopper** – If you have a chopper for sale, please give Lynn a call at 360-652-1381
- **Help Wanted** – Experienced picture framer. Working with customers and design skills required. Part-time flexibility needed, work most Saturdays. Enjoy a friendly environment in Tacoma at The Framemakers. Salary DOQ. Call Warren at 253-564-2320.

MEMBERSHIP APPLICATION & UPDATE FORM

Business Information

Company Name

Contact Name

Street Address

City

State

Zip

Phone

Fax

E-mail

Web Site

Use the space below to write a 60 space description of your business to be placed on our Web site.

Complete this form and return it with your one year membership dues of \$40. **Mail to:** EPFG, c/o Paul Miller, 4614 – 180th Place SW, Lynnwood, WA 98037. To update your information, visit our online application located on our Web site– www.myframeshop.com/epfg/members

**EPFG UPCOMING EVENTS & NOTICES****November 1998**

Date: 10th - Colorplak®
Redmond, WA - 7 PM

Topic: Nightmare on Frame Street. Bring your best nightmare customer and framing stories.

December 1998

**Happy Holidays
No Meeting**

January 1999

Date: 12th - TBA

Topic: EPFG Officer Elections

Directions to the Meeting**Colorplak®**

17830 NE 65th Street
Redmond, WA
425-883-1780

Take SR520 East off of I405. Pass Marymoore Park and take the Redmond Way exit and turn right at the signal. Swerve right onto East Lake Sammamish Pkwy just past Lumbermans. The next signal is NE 65th. Turn right and look for "Art Laminators" in the business park on your right.

The board of the EPFG is hard at work planning next years schedule. Just as it is important to plan for your store, it is important to plan for your organization. We need your help. It is very difficult to plan effectively when we can't find a shop to host a meeting until the last minute. We need shops to host meetings for January, February, July, September, October, and November of 1999. Thank you to Rainy Day Frames (Ballard) and Art & Frame (Bellingham) for signing up at the October meeting. Please consider hosting a meeting in 1999. Contact Terry Scidmore at 206-433-1145 to sign up.



T. M. Taricco
P. O. Box 411
Redmond, Washington 98073-0411

ADDRESS CORRECTION REQUESTED

President

Paul Knoop, CPF
the framemakers
253.564.2320
pknoop@earthlink.net

Vice President

Donna Rickman, CPF
Finishing Touches
425.338.0932
rrickman@aol.com

Treasurer

Paul Miller, CPF
Lake City Picture Framing
425.771.9519

Secretary

Terry Scidmore, CPF
The Mitered Corner
206.433.1145

Past President

Frank Larson, CPF
Larson Fine Art Services
425.482.0549

Board Of Directors

Joe Garitone, CPF
Larson-Juhl
800.223.0307 x455

Joe Huber

Studio Moulding
800.262.4174 x217

Ben Edwards

Framers' Inventory
888.562.2440 x449

Nancy Chapman

Bimini Designs
425.392.7334

Meeting Greeter

Lynn Clark
Lake City Picture Framing
206.363.2100

Librarian

Ray Miles
National Glass
800.521.7061

ATTENTION: FRAME SHOP