

# A SOLUTION FOR FRAMES OF ALL SHAPES & SIZES

By Paul Knoop, *the framemakers*, Tacoma, Washington

Have you ever had a customer come in with one of the old oval, or octagonal domed photos needing glass replaced? If you have dealt with these items very often, you probably know that most of them were made as a unit, and today's oval glass may not fit the frame. In the old days, there was a lack of standardization, and sizes and shapes varied widely. Well, I have found a source for custom shapes and sizes of domed glass to fit these frames. Simply provide the company a pattern of the rabbet and if they have your size as a stock item, they can ship it to you immediately. If not, they can often take the next larger size and cut it down to fit your opening. Prices are very reasonable, and their service is excellent. They can also prepare a mold to make a specially shaped or sized glass, and as you might expect, this is somewhat more expensive and takes longer to complete.

**Avery Galleries, 800-969-2459**, in Marietta, Georgia, is the source, and they will be happy to furnish you with a price schedule which shows their stock patterns and size ranges. I have used their services on several occasions, and have been very pleased with their service and workmanship.

## MEETING IN TACOMA

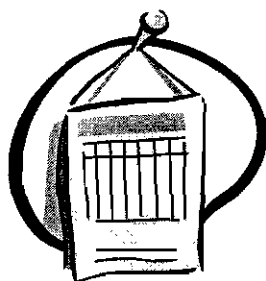

The January meeting at **the framemakers**, will be the first of a 2-part program on working with Interior Designers and Decorators. This part will be from the Designers point of view, and will feature a discussion by two award winning designers in the Tacoma area, both of whom have a very exclusive client list which includes homes, offices, country clubs, and public buildings. Make plans now to be there on Jan

12th to hear Donn Laughlin and Julie Lund discuss their varying requirements and approach to interior design.

### INSIDE THIS ISSUE

PRESIDENT'S LETTER	3
MEET AN EPFG MEMBER FRAME SHOP	6
1999 FRAMING COMPETITION	9
DIRECTIONS TO THE JANUARY MEETING	BACK
UPCOMING EVENTS	BACK



January 1999

Newsletter Cost: free to EPFG members,  
\$1.00 for non-members

Serving Alaska & Washington

# HAPPY NEW YEAR!





**FI FRAMERS' INVENTORY**

**NOW OPEN IN SEATTLE!**

**WOOD MOULDING**  
Arquati, Bay Framers' Inventory,  
LaMarche, Max, Roma, Williamson

**METAL MOULDING**  
Nielsen

**MATBOARD**  
Bainbridge, Crescent, Tru Vue

**GLASS & FOAMBOARD**  
True Vue, Sandel,  
Bientfang, Bainbridge

**EQUIPMENT**  
C&H Fletcher  
Seal Mounting

**SERVICE**  
Daily delivery in the  
Portland & Seattle Metro areas  
Will call open til 6:00 PM  
Overnight chop service

**FI**

4412 4TH AVENUE SOUTH, SEATTLE WA 98143  
5000 SE 18TH AVENUE, PORTLAND, OREGON 97202  
TOLL FREE(800)543-2467 FAX(503)238-3899

**VICTOR**  
MOULDING COMPANY

*Have You Seen?*

**Southern Comfort Line**  
**Hunt Club Line**  
**Impasto Line**  
**Tiburon Line**

IF YOU HAVEN'T, CALL YOUR SALES  
REPRESENTATIVE TODAY!

**1-800-359-2829**

**Chuck Bigford Ext. 3715**

**VM**  
3439 S.W. BOND  
PORTLAND, OREGON 97201

*Jim Jillard - Branch Manager*



HOW TO CONTACT US

**Membership Dues, Advertising  
Payments, Change of Address:**

Paul Miller, EPFG Treasurer  
4614 - 180th Place SW  
Lynnwood, WA 98037  
425-771-9519

For changes of address please  
include old and new address in-  
formation.

**General Questions:**

Contact information for the  
EPFG Officers and Board of Di-  
rectors can be found on the back  
of this newsletter.

**Online:**

[http://www.myframeshop.com/  
epfg/members/](http://www.myframeshop.com/epfg/members/)

**Classified Ad copy, Display Ad  
copy, Article Suggestions:**

Tim Taricco  
P.O. Box 411  
Redmond, WA 98073  
taricco@myframeshop.com

Non EPFG members must in-  
clude \$10 for each Classified Ad.

**Deadlines:**

This newsletter is published  
monthly on the **20th** prior to  
the month of distribution.

**Join Today:**

Return the application on  
page 9 along with \$40 to be-  
come a member of EPFG



8214-B South 192nd St., Kent, WA 98032

**FREE FREIGHT**

**On all orders over \$100.00 in OR and WA**

**JOE HUBER**

**Orders: (800) 262-4174**  
**Voice Mail Ext: 217**  
**Fax: (888) 423-1814**

The EPFG Newsletter and Internet Web Site are published  
monthly by Tim Taricco. **Mailing Address:** P. O. Box 411 -  
Redmond, Washington 98073-0411. **Phone:** (425) 885-9730  
**E-mail:** taricco@myframeshop.com **Web Site:** [http://www.  
myframeshop.com/tradeonly/](http://www.myframeshop.com/tradeonly/). **Comments and suggestions**  
about the EPFG Newsletter and Internet Web Site should be  
made to Tim Taricco. Newsletter Design © 1998 T. M. Taricco  
and Newsletter Content © 1998 Evergreen Picture Framers  
Guild. All rights reserved. Do not duplicate or redistribute in any  
form.



**Jeff Schuffman**  
Sales Representative

1433 W. Frankford Rd. #100 Carrollton, Texas 75007  
972-466-0721 • 972-466-3662 Fax  
800-527-0421 • 800-817-0524 Fax  
Ext. 882



Wholesale Picture  
Frame Supplies

2928 4th Ave S • Seattle, WA 98134  
206-292-9664  
800-423-6287

## PRESIDENT'S LETTER



Another year has gone by, and I hope that it has been a successful one for you. With the busy Holiday season, we sometimes fail to take a few minutes to stop and realize what is really important in our lives; health, family, friends, and all of the other blessings we have. The year for EPFG was a successful one, and I am

looking forward to another year of growth and improvements in our organization. Speaking of growth, we have a new volunteer to head up efforts with membership recruitment and retention; Nancy Chapman will be contacting you soon asking for your renewal or initial membership. Also, the Spring Banquet is on track, so make plans now to be at the Embassy Suites on Sunday, March 21st for education, framing competition, dinner and a great time with fellow framers. More details are forthcoming, as usual.

January's monthly meeting should prove to be interesting, with the presentation by two Interior Designers on their approach to framing, and dealing with framers. This is the first part of a two-part series, the second part being from the

framer's point of view. Donn Laughlin has a Masters Degree from University of Puget Sound, for 32 years was the Director of Visual Arts for a local private school. He has served on the board of Directors for the Tacoma Art Museum, and he was recently appointed as the interior design consultant for the Governor's mansion in Olympia. He currently has his own interior design business and has specialized in numerous commercial facilities, country clubs, etc. as well as private homes. Julie Lund and her husband, Greg, own Paper Chase Interiors in University Place. She is a graduate of University of Washington, and has won numerous awards for her designs as part of the Street of Dreams festivals, and Tacoma's annual Festival of Trees, a major charity event. Don't miss this program and its follow-on.

*Paul Knoop*  
EPFG President

Colorplak is the original art laminator for the picture framing industry. Call today to learn how Colorplak can increase sales in your business.

Our Local  
Sales Representative

**Tim Taricco**  
425-885-9730

**800-305-1953**



**CORONA**

1150 Industry Drive Tukwila, WA 98188  
Division of RCI, Inc.



The choice of professionals, CORONA Cold & Hot/Cold Vacuum presses. Complete mounting/laminating supplies. Originators of BERTO and Corona Hot/Cold Unimount adhesives..the industry mainstays for over 20 years. 'The Mounting Specialists'.

Suppliers to the Picture Framing Industry for over  
**30 years**

206.575.2727 Fax: 206.575.2667



# PRADO

*Seven golden mouldings reminiscent of regal antiquity.*

For more information on Prado and other Larson-Juhl framing products call:  
(216) 433-6002, (800) 627-1500 or (800) 438-5031

or contact your Larson-Juhl sales representative

Voice Mail: 800-223-0307

Stephen Dean - ext. 454 • Paul Anderson - ext. 456 • Joe Garitone - ext. 455

## LARSON · JUHL

ADDING ARTISTRY TO ART  
WARMTH TO LIVING

# NATIONAL GLASS

17030 WOODINVILLE-REDMOND ROAD, WOODINVILLE, WA. 98072

**QUALITY PRODUCTS AND EXCELLENT SERVICE!** NATIONAL GLASS  
INVENTORIES THE LARGEST SELECTION OF PICTURE FRAMING GLASS IN THE PACIFIC  
NORTHWEST.



NATIONAL GLASS

**TRU VUE AND SANDEL PREMIUM, REFLECTION CONTROL, SATINVIEW, CONSERVATION  
SERIES GLASS, IMAGE PERFECT, DENGLAS, AND CRYSTALVIEW.**

Now Available - AR Glass & Museum Glass!

ALSO AVAILABLE: *FOAM-X*, MIRROR AND ACRYLICS

**EVERYTHING YOU NEED AND *FREE DELIVERY* ARE ONLY A PHONE CALL AWAY!**

(425) 488-8126

1 (800) 521-7061

fax (425) 488-3712

# New Pre-Covered Lip Liner

Ask about our  
Distributors Discount.

Expanded Liner Selection

## **Framing Fabrics & Moulding International**

is very happy to introduce NEW LINERS. With the recent expansion of our liner offerings, we are able to provide our customers with a complete liner selection, at very competitive prices. These seven new additions include a flat profile in two sizes, a bevel profile in two sizes and a scoop profile in three sizes, all with hand-finished lips of bright gold, antique gold and antique silver. These lip liners are available in four fabrics, 100% BELGIQUE Natural Linen; Union Blend of MANHASSET Natural and Oyster and Antique Satin MARQUIS Black.

## LIP FINISHES

Bright Gold ❖ Antique Gold ❖ Antique Silver

## FABRICS

Manhasset Natural ❖ Manhasset Oyster  
Belgique Natural ❖ Marquis Black

All are pre-covered. However, we are also able to meet most of your custom needs (*Custom Wraps*), just call and ask our Customer Service Department personnel. Upon request, we can cover our lip liners with any of the 500 fabrics we sell. A 50 ft. minimum applies to liners cut to 6 & 4 or 5 & 5 ft. lengths; a 100 ft. is required on liners in standard 10 ft. lengths.

These liners are in addition to the original thirty liner profiles we offer in Primed, Pre-covered and *Custom Wrapped* both in length and chop.

### FLAT

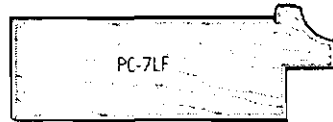
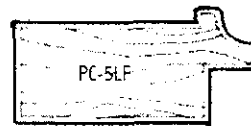

### BEVEL

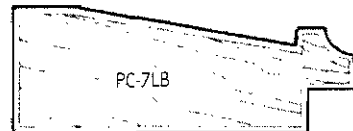

### SCOOP

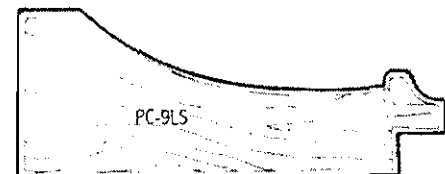
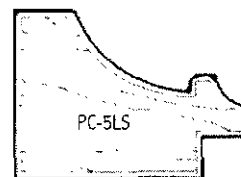

Shown Actual Size



## HARTUNG GLASS INDUSTRIES

- ◆ Complete line of Acrylics; Clear, Non-Glare & UV.
- ◆ We carry Tru-View, Sandel & Crystalview
- ◆ Specializing in beveled mirrors for framing.
- ◆ Next day delivery from Everett to Tacoma.
- ◆ Over 20 years experience with picture framers.
- ◆ Call us and have a Customer Service Representative specializing in your needs help you.



17830 West Valley Highway, Seattle, WA 98188  
(206)656-2626, (800)552-2227, FAX (206)656-2601

## MEET AN EPFG MEMBER FRAME SHOP

Located in a small but busy shopping center near Tacoma Community College, **the framemakers** has been in business there for 25 years, but under new ownership for the past 5. The owner, Warren Dodge, purchased the shop in Feb of 1994 and began to change the focus from one of metal frame, no mats poster with a heavy emphasis on do-it-yourself to that of quality, conservation framing. While there is still much to be done, anyone who has been in the store for the first time after his ownership is amazed at the transformation. Now, **the framemakers** has a diverse clientele who are quickly becoming educated to the proper way to frame original, limited editions, and needle art. Numerous local artists rely on **the framemakers** for their framing, and needlework has become a large part of their business. Do it yourself is a thing of the past, and conservation materials are the norm in over 90 percent of the jobs currently in the shop.

Although the business is still small, employing only 2 framers in addition to Warren, there is space to grow, and the future is promising. The frame makers has hosted several EPFG meetings in the past, and is the location for the January meeting. Hope to see you there.

### NURRE CAXTON

FRAMES OF DISTINCTION



*"We're Obsessed  
With Customer  
Satisfaction"*

#### Pamela Neal

Sales Representative for  
Washington, Wyoming, Montana  
Oregon and Idaho

1-800-255-1942, press 6, ext. 4011  
for voice mail  
1-800-377-3300 fax  
1-800-910-8966 pager

We promise friendly, reliable service  
same day chop service free UPS  
for orders of 3 chops or more  
(wood and Nielsen metal combined)



# Chances are you started out with a LOGAN Mat Cutter Have you seen what we've done lately?

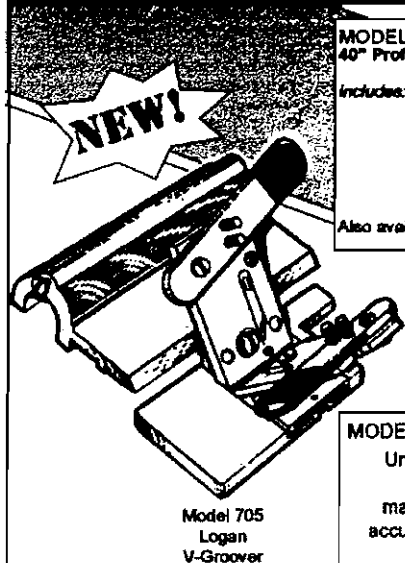

Model 705  
Logan  
V-Groover

### MODEL #650 *Framer's Edge* MAT CUTTER 40" Professional Production Matcutter

- Includes:
- Ergonomically designed Dual straight and Bevel cutting head
  - Production Stops
  - Parallel Mat Guide
  - Start and Stop Indicator for line to line cutting.
  - 27" Squaring Arm

**Suggested List Price \$599.95**

Also available in a 60" version MODEL #660 *Framer's Edge* \$799.95

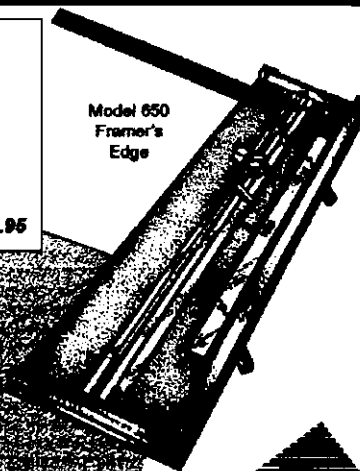

Model 650  
Framer's  
Edge

### MODEL 705 LOGAN V-Groover patented

Unique "push-pull" surface V-Groover that cuts beautiful V-Grooves on the surface of the matboard. Works entirely with stops provided for accurate V-Grooving in seconds with zero overcuts. Endless creative possibilities!!

**Suggested List Price \$125.00**

### MODEL 706 Universal V-Groover patented

Works on professional mat cutters using a 5/8" thick cutting bar rod including Fletcher<sup>®</sup> and C&H<sup>®</sup> professional matcutters.

**Suggested List Price \$150.00**



1100 BROWN SERIES • WYALACONDA, BRITISH COLUMBIA  
NATIONWIDE TOLL FREE 1-800-731-4272  
CALL FREE FAX 800/331-6129

See us at <http://www.artproducts.com>

E-mail: [Logan-Graphic-Products@worldnet.att.net](mailto:Logan-Graphic-Products@worldnet.att.net)

Need Training for New Employees?

**SEE WHAT YOUR DOLLAR  
CAN DO IN CANADA**

## The Canadian Picture Framer's School

#1, 20678 Duncan Way  
Langley, B.C.

providing excellent thorough  
instruction in picture framing for  
over 10 years. Phone or fax  
for more info:

Ph: 604-533-5328  
Fax: 604-533-9680

Software Suite for Windows 95 and earlier  
Galleries & Frame shops Networking User Friendly!

# PERENSOFT TRIO!

- Art
- Customers
- Framing

Point of Sale and Business Management  
suite with optional WIZARD™ mat cutter link.  
See why people are switching to FS TRIO!  
Seattle 206-282-1775.



## TRUE GLASS

FOR EVERYONE WHO NEEDS

### PREMIUM SERIES GLASS

- PREMIUM CLEAR\*
- REFLECTION CONTROL\*
- AR™ REFLECTIVE FREE

### CONSERVATION SERIES GLASS

- CONSERVATION CLEAR\*
- CONSERVATION  
REFLECTION CONTROL\*
- MUSEUM GLASS\*



SEATTLE, WA 98133



**THE ART DOCTOR**

Restoration of Oil Paintings, Japanese Screens,  
Art on Paper, Art Objects

**NANCY G. WHITE**  
Restorer

(206) 783-9160  
By Appointment

Williamson • TriVue Glass/Miller Matboard • Clark • Designer Wood & Metal  
Piedmont • Colonial • Burnish • Ivancore

**INTRODUCING:**  
5 New Library Leather Matboards from Miller  
plus 4 New Slate & Shagreen  
Call for samples

METAL FRAMES ART



4810 EAST ALKI WAREHOUSE #5  
PHONE 800 341-7329 509 525-3440

SPOKANE WASHINGTON 99212  
FAX 800 344-5003 509 335-3466

# 1999 EPFG BOARD ELECTION

Remember to come to the January meeting to vote in the 1999 EPFG Officers and Board of Directors.

## EXECUTIVE BOARD

### President (1 year remaining)

Paul Knoop, CPF – Framers at the framemakers, Tacoma.

### Vice President (2 year term)

Donna Rickman, CPF – Owner of Finishing Touches, Mill Creek.

### Secretary (1 year remaining)

Terry Scidmore, CPF – Owner of The Mitred Corner, Seattle.

### Treasurer (2 year term)

Kiyoshi Toda, CPF – Owner of Accent On Framing, Issaquah.

## BOARD OF DIRECTORS

Ben Edwards (1 year remaining) Sales rep. for Framers' Inventory.

Joe Huber (1 year remaining) Sales rep. for Studio Moulding.

Joe Garitone, CPF (1 year remaining) Sales rep. for Larson Juhl.

Ray Miles (2 year term) Sales rep. for National Glass.

**Colorful, Creative,  
Pure & Strong...**



**Crescent Rag Mat**  
100% Cotton Museum Board

The choice of Artists & Picture Framing Professionals,  
for archival and conservation matting.  
Acid-free and lignin-free.

Send in your business card to receive  
your **FREE Rag Mat Booklet (RM-100)**.

Crescent Carboard Company 100 W. Willow Road, Wheeling, IL 60090 U.S.A.



**Pacific Framing Supply**

*"Serving all of your framing needs"*

**Brad Airhart & John Cave**

Salem, OR 97304

Phone: 1-800-872-4445

FAX: 1-503-363-7273

Woodinville, WA 98072

Phone: 1-800-292-3202

FAX: 1-206-486-4978





# 1999 FRAMING COMPETITION

By Nancy Chapman

Last year at the Spring Festival EPFG sponsored an "Open" Framing Competition. At our convention this year we will host a "Print" Competition. The purpose of this contest is to encourage the creativity of the members and to showcase individual skills, techniques and styles.

Since the Festival is on March 21<sup>st</sup>, the first day of spring, it was decided at the last board meeting that it would be appropriate to use a print celebrating spring and one that would also inspire a wide variety of interpretation in framing. Molly Boone-Neese made an appointment at Winn-Devon Art Group, and the two of us met with Tomas Shoaf at their offices in Seattle. We felt it was appropriate to choose a small print to make framing easier, so *Wild Irises* by Greg Singley in the small format was selected. The paper is 11 x 14 and the image is 9 ½ x 11 ½.

Winn-Devon was very gracious in their help, and offered the

prints to us at ½ of their wholesale value. Prints will be available to members for \$2.50 beginning at the January EPFG Guild meeting. Although the print itself is inexpensive treat it as a piece of art that is valuable to one of your customers. Included with each print will be an "Open Framing Competition Form" that needs to be filled out and turned in with the entry at the conference. This form is important because it helps the judges in their evaluation. Also you will receive a copy of the "Judging Criteria" so you will know exactly what each entry will be judged on.

Framing competitions are one of the best opportunities for professional framers to demonstrate well thought-out framing designs and concepts. We look forward to your participation in EPFG's conference this March 21<sup>st</sup>. Recognition will be given for 1<sup>st</sup>, 2<sup>nd</sup>, 3<sup>rd</sup>, and People's Choice Award and we hope that all of you will want to show off your best work!

## MEMBERSHIP APPLICATION & UPDATE FORM

### Business Information

Company Name

Contact Name

Street Address

City

State

Zip

Phone

Fax

E-mail

Web Site

Use the space below to write a 60 space description of your business to be placed on our Web site.

Complete this form and return it with your one year membership dues of \$40. **Mail to:** EPFG, c/o Paul Miller, 4614 - 180th Place SW, Lynnwood, WA 98037. To update your information, visit our online application located on our Web site- [www.myframeshop.com/epfg/members](http://www.myframeshop.com/epfg/members)

**January 1999**

**5th** – Board Meeting

**12th** – General Meeting – 7 PM

*The Framemakers* – Tacoma  
Working with Designers Part I

**February 1999**

**9th** – General Meeting – 7 PM

*Framers' Inventory* – Seattle

**March 1999**

**21st** – Spring Festival

*Embassy Suites* – Tukwila

**30th** – Board Meeting

**April 1999**

**13th** – General Meeting – 7 PM

*Art And Frame* – Bellingham

**May 1999**

**11th** – General Meeting – 7 PM

*The Mitered Corner* – Seattle

**25th** – Board Meeting

**June 1999**

**8th** – General Meeting – 7 PM

*Rainy Day Frames* – Seattle

**July 1999**

**13th** – General Meeting – 7 PM

*Lake City Picture Framing* – Seattle

**27th** – Board Meeting

**August 1999**

Annual Picnic

**Directions to the January meeting** – Take exit 32 from I-5 West toward Gig Harbor on SR 16 and after approximately 2 miles, exit onto 19th St headed West. Follow the signs to University Place, and after looping back over 16, go 2 miles. **The framemakers** is on the left behind the McDonalds on the corner.

**the framemakers** - 6724 W 19th St; University Place, WA 98466; Phone: (253) 564-2320



T. M. Taricco  
P. O. Box 411  
Redmond, Washington 98073-0411

ADDRESS CORRECTION REQUESTED

**President**

Paul Knoop, CPF  
*the framemakers*  
253.564.2320  
pknoop@earthlink.net

**Vice President**

Donna Rickman, CPF  
*Finishing Touches*  
425.338.0932  
rickman@aol.com

**Treasurer**

Paul Miller, CPF  
*Lake City Picture Framing*  
425.771.9519

**Secretary**

Terry Scidmore, CPF  
*The Mitered Corner*  
206.433.1145

**Past President**

Frank Larson, CPF  
*Larson Fine Art Services*  
425.482.0549

**Board Of Directors**

Joe Garitone, CPF  
*Larson-Juhl*  
800.223.0307 x455

Joe Huber

*Studio Moulding*  
800.262.4174 x217

Ben Edwards

*Framers' Inventory*  
888.562.2440 x449

Nancy Chapman

*Bimini Designs*  
425.392.7334

**Librarian**

Ray Miles  
*National Glass*  
800.521.7061

**ATTENTION: FRAME SHOP**

