

GO TEAM!

By Joe Huber. Studio Moulding

Baseball cards, kid's soccer team photos, NASCAR scale models, autographed basketball shoes (they're big), antique golf clubs, Ken Griffey Jr. posters, ticket stubs, sports jerseys, home-run balls.

Framing sports memorabilia is a regular part of the framers craft, often requiring a high level of creativity and skill to display effectively and safely. Sports fans and collectors are frequently passionate about their hobby. They are likely to have a substantial emotional or financial investment in the objects they bring to us. How can we offer them a unique and dynamic presentation for their collections?

One idea is to incorporate team colors into your moulding design. Experiment with stacked color combinations for the Mariners, Seahawks and Sonics, as well as the UW Huskies and WSU Cougars. Don't forget your local High School team's colors. By having these sample combinations pre-joined, you will have ready-to-show team color corner samples. Consider a small sports framing section for your sample wall to further promote the idea.

Another idea is to use team or college auto window decals, clothing patches or even bumper stickers as decorative elements in your design. Team logo mat cuts can offer a unique look. Remember to be bold with your design. Subtlety and understatement

(Continued on page 3)

PRESIDENT'S LETTER

By Paul Kuoop, the framemakers, Tacoma



Well, another month has gone by already, and summer is just around the corner. Also around the corner is the next Guild meeting, and, as promised, the subject is pricing. This topic always generates considerable discussion, and that's one of the benefits of attending our meetings. The meeting will be a round table discussion, and we need you there to contribute. The opportunity to see what other framers are doing, what they are thinking, and how their ideas can be

applied to your business is what membership does for you. While on the subject of meetings, the North and South Sound meetings earlier this month were quite sparse

(Continued on page 6)

INSIDE THIS ISSUE

CLASSIFIED ADS	5
MORE FROM MARCH	9
EVENTS CALENDAR	BACK



May 1999

Newsletter Cost: free to EPFG members, \$1.00 for non-members

Serving Alaska & Washington

THIS MONTH'S MEETING

This month's meeting will be on Tuesday, May 11th at The Mitered Corner in South Seattle. At the meeting, we will review the 1999 Pricing for Profit survey results along with discussing numerous pricing models. Automated pricing with a computer versus the manual chart and calculator pricing will be discussed. Bring your ideas and opinions and join your fellow framers for a very informative evening. Directions to the meeting are located on the back of this newsletter.

INTERNET SURVEY

At the Bellingham meeting last month, it was discussed to bring back the EPFG Web site. Over 80% of the people attending the meeting had Internet access and felt the Web site would help give our members information faster. What do you think? Send your comments to: epfg@myframeshop.com



HOW TO CONTACT US

Membership Dues, Advertising Payments:

Kioski Toda, EPFG Treasurer
3058 Issaquah-Pine Lake Road
Issaquah, WA 98027
Phone: (425) 557.5494

Change of Address:

Nancy Chapman
15209 263 Ave. SE
Issaquah, WA 98027
Phone: (425) 392.7334
himinidesigns@hotmail.com

For changes of address please include old and new address information.

Classified Ad Copy, Display Ad Artwork:

Tim Taricco
P.O. Box 411
Redmond, WA 98073
Fax: (630) 839-4591
frameguy@myframeshop.com

Classified ads

Free for EPFG members, \$10 for non-members

Display Ad Artwork

Digital artwork is requested. PC format preferred / Mac format okay. Submit via e-mail or on disk.

Publishing Deadline

20th of the month prior to distribution.

1999 EPFG Officers

President

Paul Knoop, CPF
the framemakers
253.564.2320
pknoop@earthlink.net

Vice President

Donna Rickman, CPF
Finishing Touches
425.338.0932
rrickman@aol.com

Treasurer

Kiyoshi Toda, CPF
Accent On Framing
425.557.5494

Secretary

Terry Scidmore, CPF
The Mitered Corner
206.433.1145

Board Of Directors

Joe Garitone, CPF
Larson-Juhl
800.223.0307 x455

Joe Huber

Studio Moulding
800.262.4174 x217

Ben Edwards

Framers' Inventory
888.562.2440 x449

Ray Miles

National Glass
800.521.7061

Past President

Frank Larson, CPF
Larson Fine Art Services
425.482.0549

The EPFG Newsletter is published monthly by Tim Taricco.

Mailing Address: P. O. Box 411 - Redmond, Washington 98073-0411. **Phone:** (425) 885-9730 **Fax:** (630) 839-4591

E-mail: frameguy@myframeshop.com **Web Site:** <http://www.myframeshop.com/tradeonly/>. Newsletter Design ©1999 T. M. Taricco and Newsletter Content ©1999 Evergreen Picture Framers Guild. All rights reserved. Do not duplicate or redistribute in any form.

Need Training for New Employees?

**SEE WHAT YOUR DOLLAR
CAN DO IN CANADA**

**The Canadian Picture
Framer's School**

#1, 20678 Duncan Way
Langley, B.C.

providing excellent thorough
instruction in picture framing for
over 10 years. Phone or fax
for more info:

Ph: 604-533-5328

Fax: 604-533-9680

**STUDIO
MOULDING**

8214-B South 192nd St., Kent, WA 98032

FREE FREIGHT

On all orders over \$100.00 in OR and WA

JOE HUBER

Orders: (800) 262-4174

Voice Mail Ext: 217

Fax: (888) 423-1814



CORONA

1150 Industry Drive Tukwila, WA 98188
Division of RCI, Inc.



The choice of professionals, CORONA Cold & Hot/Cold Vacuum presses. Complete mounting/laminating supplies. Originators of BERTO and Corona Hot/Cold Unimount adhesives..the industry mainstays for over 20 years. 'The Mounting Specialists'.

Suppliers to the Picture Framing Industry for over
30 years

206.575.2727 Fax: 206.575.2667



Jeff Schuffman
Sales Representative

1433 W. Frankford Rd. #100 Carrollton, Texas 75007
972-466-0721 • 972-466-3662 Fax
800-527-0421 • 800-817-0524 Fax
Ext. 882



2928 4th Ave S • Seattle, WA 98134
206-292-9664
800-423-6287

Wholesale Picture
Frame Supplies

Software Suite for Windows 95 and earlier
Galleries & Frame shops Networking User Friendly!

FERENSOFT
TRIO!

- Art
- Customers
- Framing

Point of Sale and Business Management suite with optional WIZARD™ mat cutter link. See why people are switching to FS TRIO! Seattle 206-282-1775.



GO TEAM!

CONTINUED

(Continued from page 1)

are not qualities usually appreciated in the world of big-time sports!

For object framing, consider shadow boxes with hinged or removable fronts. This can provide ready access for the object to be shown to fellow collectors and friends, without having to remove the entire framed piece from the wall in order to gain rear access.

By thinking through these ideas and knowing your options for stacked mouldings, decorative design elements and specialty hardware, you can be confident in the success and profitability of each project. And, have fun! After all, how often do you get to stack purple and gold frames together.

TRU VUE GLASS
FOR EVERY FRAMING NEED

<p>PREMIUM SERIES GLASS</p> <ul style="list-style-type: none"> • PREMIUM CLEAR™ • REFLECTION CONTROL™ • AIR™ REFLECTIVE FREE 	<p>CONSERVATION SERIES GLASS</p> <ul style="list-style-type: none"> • CONSERVATION CLEAR™ • CONSERVATION REFLECTION CONTROL™ • MUSEUM GLASS™
--	--

CALL FOR A FREE CATALOG
TOLL FREE 1-800-283-5700



34 Colors

Need to hire another framer?
Make your life easier and
make more money instead,
hire Colorplak as your framer.

1-800-305-1953

NIELSEN & BAINBRIDGE

LINDA GARRETT
Regional Manager

Voice Mail: (800) 524-0434 Ext. 8433

6280 Artesia Blvd.
Buena Park, CA 90622

(800) 321-2934
Fax (714) 522-7890



PRADO™

Seven golden mouldings reminiscent of regal antiquity.

For more information on Prado and other Larson-Juhl framing products call:
(216) 433-6002, (800) 627-1500 or (800) 438-5031

or contact your Larson-Juhl sales representative

Voice Mail: 800-223-0307

Stephen Dean - ext. 454 • Paul Anderson - ext. 456 • Joe Garitone - ext. 455

LARSON · JUHL

ADDING ARTISTRY TO ART
WARMTH TO LIVING

NATIONAL GLASS

17030 WOODINVILLE-REDMOND ROAD, WOODINVILLE, WA. 98072

QUALITY PRODUCTS AND EXCELLENT SERVICE! NATIONAL GLASS
INVENTORIES THE LARGEST SELECTION OF PICTURE FRAMING GLASS IN THE PACIFIC
NORTHWEST.



NATIONAL GLASS

**TRU VUE AND SANDEL PREMIUM, REFLECTION CONTROL, SATINVIEW, CONSERVATION
SERIES GLASS, IMAGE PERFECT, DENGLAS, AND CRYSTALVIEW.**

Now Available - AR Glass & Museum Glass!

ALSO AVAILABLE: *FOAM-X*, MIRROR AND ACRYLICS

EVERYTHING YOU NEED AND *FREE DELIVERY* ARE ONLY A PHONE CALL AWAY!

(425) 488-8126

1 (800) 521-7061

fax (425) 488-3712



SEATTLE, WA 98133



THE ART DOCTOR
Restoration of Oil Paintings, Japanese Screens,
Art on Paper, Art Objects

NANCY G. WHITE (206) 783-9160
Restorer By Appointment

CLASSIFIED ADS

If you have something to sell, do it here!!! Classified ads are FREE for EPFG members and \$10 for non-members. This is just another benefit your \$40 membership fee gives you.

• Clark • Designer Wood & Metal • Piedmont • Colonial • Burnich • Williamson • Foamcore

Tru Vac Glass/Miller Matboard

INSPIRED BY INDIA'S FABRICS AND TRADITIONAL DESIGNS, KALI SPOTLIGHTS BEAUTIFUL GOLD LEAF WITH RICH UNDERTONES OF COLOR AND PROFILES THAT FIT TODAY'S UPSCALE CUSTOM FRAMING DESIGNS.

METAL FRAMES ART



6010 EAST ALKI WAREHOUSE #5
PHONE 800 344-7329 509 535-3440

SPOKANE WASHINGTON 99212
FAX 800 344-5003 509 535-3466



Pacific Framing Supply
"Serving all of your framing needs"

Brad Airhart & John Cave

Salem, OR 97304 Phone: 1-800-872-4445
FAX: 1-503-363-7273

Woodinville, WA 98072 Phone: 1-800-292-3202
FAX: 1-206-486-4978

It's About Choices...

Crescent Regular Matboard, with the greatest array of colors, is the **right choice** for everyday decorative framing. Crescent Whitecore Basics, with its non-yellowing white core, is the **ideal choice** for the design requirements of today's contemporary décor. Crescent Rag Max remains the **only choice** for conservation framing.

With its naturally 100% acid- and lignin-free core, it's the premier choice for protecting priceless works of art and irreplaceable memories.



Crescent
We Give You The Right Choice!
<http://www.crescent-cardboard.com>

Crescent Cardboard Company, 100 West Willow Road, Wheeling, Illinois 60090, Tel. 1-847-537-3400, Fax 1-847-537-7153

- **READY TO WORK FOR A COMPANY WITH GREAT BENEFITS??** Daniel Smith, Inc. Fine Artists' Retailer seeks experienced picture framer for our SEATTLE location. Design work with customers, ordering, complete framing. Send resume to: H/R Daniel Smith 4150 First Ave South, Seattle, WA 98134 or fax resume: 206/224-3567, or call 206/224-0407. EOE
- **FRAME SHOP FOR SALE:** Health forces immediate sale. After 28 years, The Frame Up at Totem Lake has a year and a half left on its lease, with an option. \$25,000 buys complete inventory: chopper, joiner, metal saw, mat cutter, oval master, glass cutter, vacumount machine, heat press, work tables, print bins, framed prints, hundreds of ready made frames, many commercial accounts, as well as 28 years of clientele. Average year 90 to 100 thousand and growing. Great opportunity for anyone wanting to pursue a career in this field. Contact Dyann Webb 425/821-1331 or 425/823-8286.
- **EQUIPMENT FOR SALE:** 40 x 60 Corona Vacuum Press, complete \$600. C&H 60" Pro Wall Cutter, like new \$800. Fletcher 2100 40" mat cutter w/ production stops, \$600. Eight department cash register, new \$80. Zon Jr. XL credit card terminal, \$150. To view the equipment, call Philip at 206/281-0054.
- **MAT CUTTER FOR SALE:** C&H 60" mat cutter with measuring stops and squaring arm, \$650. Contact Lisa at 253/565-3711.
- **THUMBNAILER FOR SALE:** Includes router bits and inserts, \$500. Contact Lisa at 253/565-3711.
- **SHRINK WRAPPER FOR SALE:** Traco 40" Super Sealer with heat gun, \$150. Contact Lisa at 253/565-3711.



FI FRAMERS' INVENTORY

NOW OPEN IN SEATTLE!

WOOD MOULDING
Arquati, Bay, Framers' Inventory,
LaMarche, Max, Roma, Williamson

METAL MOULDING
Nielsen

MATBOARD
Bainbridge, Crescent, Tru Vue

GLASS & FOAMBOARD
True Vue, Sandel,
Bienfang, Bainbridge

EQUIPMENT
C&H, Fletcher
Seal Mounting

SERVICE
Daily delivery in the
Portland & Seattle Metro areas
Will call open til 6:00 PM
Overnight chop service

FI

4412 4TH AVENUE SOUTH, SEATTLE WA 98143
5000 SE 18TH AVENUE, PORTLAND, OREGON 97202
TOLL FREE (800) 543-2467 FAX (503) 238-3899

VICTOR
MOULDING COMPANY

Have You Seen?

Southern Comfort Line
Hunt Club Line
Impasto Line
Tiburon Line

IF YOU HAVEN'T, CALL YOUR SALES
REPRESENTATIVE TODAY!

1-800-359-2829

Chuck Bigford Ext. 3715

3439 S.W. BOND
PORTLAND, OREGON 97201
Jim Jillard - Branch Manager

PRESIDENT'S LETTER CONTINUED

(Continued from page 1)

in attendance. The meeting in Yakima is next week, so we will see how it goes. The point is, should we continue to have meetings outside of the Seattle metro area? It seems that most of our meetings are attended by the same (relatively) few members anyway, so should we try to expand our coverage? I wonder if the lack of attendance was due to location, day and time, subject matter, or just plain lack of interest. Any thoughts you have would be welcome.

Computers: do you use one at work? Do you have access to the Internet? I found a very informative site on the net last week, hosted by the American Institute for Conservation of Historic and Artistic Works (AIC). Among other things, they have information available on caring for paper items and photos that have gotten wet e.g. due to floods, burst pipes etc. It makes interesting reading, and is something many of us need to know about in order to properly advise our customers. There are many other sites of specific interest to picture framers and framing, and that alone is something that would help in your business. Maybe now is the time to take the plunge and move to the computer age. Many of our members would be happy to advise you about how to get started, so why not give them a call.

We are still looking for program ideas and articles for the newsletter, so let's hear from you.

Paul Knoop
EPFG President

NURRE CAXTON
FRAMES OF DISTINCTION

 *"We're Obsessed
With Customer
Satisfaction"*

Pamela Neal
Sales Representative for
Washington, Wyoming, Montana
Oregon and Idaho

1-800-255-1942, press 6, ext. 4011
for voice mail
1-800-377-3300 fax
1-800-910-8966 pager

We promise friendly, reliable service.
same day chop service, free UPS
for orders of 3 chops or more
(wood and Nielsen metal combined)



CHOP AND MOULDING CO.

1516 East Cedar Street, Ontario, California 91761
(909) 923-3317 / (800) 582-3091 / Fax (909) 947-5251

Chop Service
and Full Line
Distributor For:

F & G Hardwoods
and
F & G Honor Mouldings

Readily
Available
Liners with or
without Filets

Piedmont
Mouldings

Decor
Mouldings

Designer
Mouldings

Crescent Mat
Board

AMS Hardware

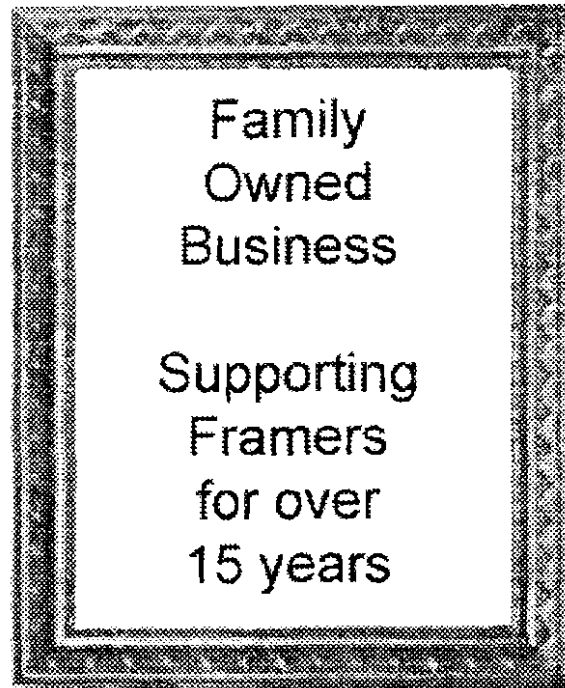

Same Day
Shipping

Dependable
Service

Competitive
Prices

Production
Framing
Capability

Prices subject to change without notice.

Toll Free FAX Order Number (800) 868-5501

...A Chop Service That Is A Cut Above The Competition

Wholesale to the Framing Community



with
Gold Moulding
 from
F & G



Item Number	Description (W x H)	Chop Price
06-541	Gold Bamboo (3/4" x 1")	3.00
12-2210	Gold leaves, tan wash (1 1/4" x 1")	2.15
13-1103	Gold, red scratch, black webbing (1 1/2" x 1")	3.59
14-2186	Gold, red scratch, black webbing (1 1/4" x 1")	1.86
14-2210	Gold braiding, with beads (1 1/4" x 3/4")	2.00
20-2170	Gold fish scale (2" x 1 1/4")	3.86
20-2186	Gold, red scratch, black webbing (2" x 1 1/4")	3.86
20-2717	Silver fish scale (2" x 1 1/4")	3.86
20-2718	Silver, Gold lip, black webbing (2" x 1 1/4")	3.86
20-2204	Silver, Defleur, brown wash (2" x 1 1/4")	4.56
20-2205	Gold, Defleur, brown wash (2" x 1 1/4")	4.56
20-2206	Gold, Defleur, Grey wash (2" x 1 1/4")	4.56
20-2210	Gold leaves, tan wash (2 1/4" x 1 1/2")	3.99
24-2169	Gold, red scratch, black webbing (3 1/2" x 1 1/2")	5.70
26-607	Ornate Gold, spots, beading (2 3/4" x 1")	4.15
30-2210	Gold braiding, with beads (2 1/8")	3.99
33-606	Gold, Grey wash, heavy ornate, specks (3 1/2" x 1 3/4")	7.57
36-2211	Brass Gold, brown wash, specks (3 1/2" x 1 3/4")	9.56
36-2725	Pewter, rope, Grey wash, specks (3 1/2" x 1 3/4")	9.56
52-1267	Antique Silver, leaves, cream wash (5 1/4" x 2 3/4")	N/A
52-1268	Antique Gold, leaves, cream wash (5 1/4" x 2 3/4")	N/A
52-1269	Brass Gold, leaves, cream wash (5 1/4" x 2 3/4")	N/A

**F & G Chop and Moulding
 Company**

909 923-3317 • 800 582-3091
 Fax 909 947-5251
 1516 East Cedar Street
 Ontario Ca 91761





HARTUNG
GLASS INDUSTRIES

Hartung Glass was the first company in the Northwest Region to deliver to the Picture Framing Industry. We have been serving the Picture Framers in our area for over twenty years and offer the largest inventory of stock sheets in the Pacific Northwest. We feature all of the top manufacturers, including Sandel, Tru-Vue, and Cyro, with scheduled deliveries to most areas of Washington. We carry many types of framing glass, including:

- | | |
|-----------------|--------------------|
| Clear | Sandel Superior |
| Anti-Reflection | Sandel Crystalview |
| Non-Glare | Tru-Vue & Sandel |
| Conservation | Tru-Vue |
| Preservation | Sandel |
| Museum Glass | Tru-Vue |

Call today to schedule a delivery!

*Hartung now stocks
3/16 mirror with 1"
bevel for framing.
Call our helpful cus-
tomer Service De-
partment today to
place your order!*

425/656-2626
800/551-2227

**Chances are you started out with a LOGAN Mat Cutter
Have you seen what we've done lately?**

NEW!

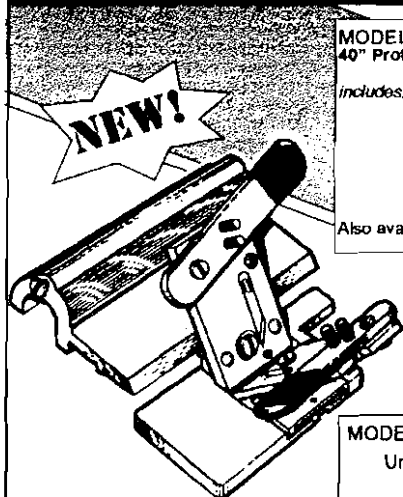

Model 705
Logan
V-Groover

MODEL #650 Framer's Edge MAT CUTTER
40" Professional Production Matcutter

- includes:*
- Ergonomically designed Dual straight and Bevel cutting head
 - Production Stops
 - Parallel Mat Guide
 - Start and Stop Indicator for line to line cutting.
 - 27" Squaring Arm

Suggested List Price \$599.95

Also available in a 60" version MODEL #660 Framer's Edge \$799.95

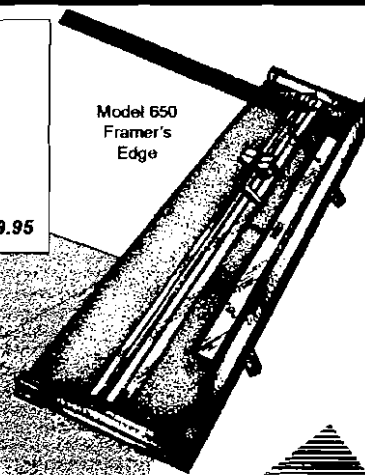

Model 650
Framer's
Edge

MODEL 705 LOGAN V-Groover patented

Unique "push-pull" surface V-Groover that cuts beautiful V-Grooves on the surface of the matboard. Works entirely with stops provided for accurate V-Grooving in seconds with zero overcuts. Endless creative possibilities!!

Suggested List Price \$125.00

MODEL 706 Universal V-Groover patented

Works on professional mat cutters using a 5/8" thick cutting bar rod including Fletcher® and C&H® professional matcutters.

Suggested List Price \$150.00



GRAPHIC PRODUCTS, INC.
1100 BROWN STREET • WALCANDA, ILLINOIS 60094
NATIONWIDE TOLL FREE 1-800-731-6222
TOLL FREE FAX 800/331-4329

See us at <http://www.artproducts.com>
E-MAIL: Logan-Graphic-Products@worldnet.att.net

New Pre-Covered Lip Liner

Ask about our
Distributors Discount.

Expanded Liner Selection

Framing Fabrics & Moulding International

is very happy to introduce NEW LINERS. With the recent expansion of our liner offerings, we are able to provide our customers with a complete liner selection, at very competitive prices. These seven new additions include a flat profile in two sizes, a bevel profile in two sizes and a scoop profile in three sizes, all with hand-finished lips of bright gold, antique gold and antique silver. These lip liners are available in four fabrics, 100% BELGIQUE Natural Linen; Union Blend of MANHASSET Natural and Oyster and Antique Satin MARQUIS Black.

LIP FINISHES

Bright Gold ❖ Antique Gold ❖ Antique Silver

FABRICS

Manhasset Natural ❖ Manhasset Oyster
Belgique Natural ❖ Marquis Black

All are pre-covered. However, we are also able to meet most of your custom needs (*Custom Wraps*), just call and ask our Customer Service Department personnel. Upon request, we can cover our lip liners with any of the 500 fabrics we sell. A 50 ft. minimum applies to liners cut to 6 & 4 or 5 & 5 ft. lengths; a 100 ft. is required on liners in standard 10 ft. lengths.

These liners are in addition to the original thirty liner profiles we offer in Primed, Pre-covered and *Custom Wrapped* both in length and chop.

FLAT

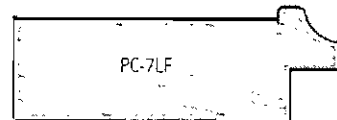

BEVEL

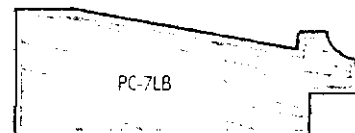
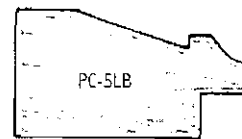

SCOOP

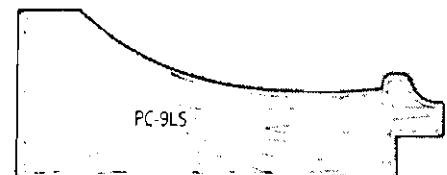
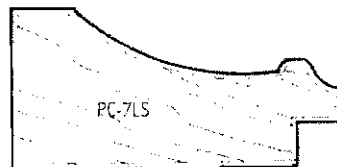
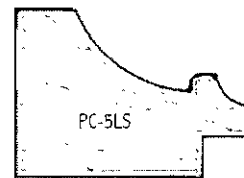

Shown Actual Size



MORE FROM MARCH

By Terry Scidmore, The Mitered Corner, Seattle

The Evergreen Picture Framers Guild Education Festival, held March 21 at the Embassy Suites in Tukwila, was a great success. Festival attendees had the opportunity to attend long and short seminars covering a variety of subjects. The seminar teachers presented excellent programs that inspired and challenged class participants. Many people left with new ideas and rekindled enthusiasm for their art.

Following the classes, participants had the chance to view the print competition entries and to vote for their favorites. After dinner, featured speaker Dennis Tilley talked about the need in the picture framing industry to recognize and appreciate the skill, education and dedication the job entails. He spoke of changing the public view of the picture framer. He jokingly said that he hopes someday framers will be known as "Art Enhancement Technicians," a moniker that upgrades the image of the picture framer and better describes what we really do. Dennis also pointed out how important organizations such as EPFG are to improving our ability to do our work more creatively, more efficiently, and with more confidence. Dennis urged people to get involved with the EPFG as an important step in improving the industry for all.

The EPFG Board encourages everyone who attended this year's festival to help with next year's event. Your involvement is needed and welcome all year long. We would love to have people volunteer to teach a class, write an article, suggest a meeting topic, or host a meeting. Don't just think about it – **do it!**

UNIVERSAL Framing Products

Edgar Solares
Account Representative
Telephone • 206-440-1545

9415 Telfair Avenue • Sun Valley CA 91352
Telephone • 818-767-8700 • 800-668-3627

Fabric & Liners

The Softer Side of Framing

Hundreds of colors and textures --- Exclusive pH Neutral Fabrics

Frank's

Fabrics for Framers

Dial Toll-Free (888) F.FABRIX (332-2749)

May 1999

11th – General Meeting – 7 PM

The Mitered Corner – Seattle
Pricing Round Table

25th – Board Meeting

June 1999

8th – General Meeting – 7 PM

Accent On Framing – Issaquah
Tricks of the Trade

July 1999

13th – General Meeting – 7 PM

Lake City Picture Framing –
Seattle
Fabric Mats

27th – Board Meeting

**DIRECTIONS
TO THE MEETING**

The Mitered Corner
11002 – 1st Avenue South
Seattle
206/433-1145

These directions are the easiest way to get to The Mitered Corner, not necessarily the fastest way.

Take I-5 either North or South to South Center. Exit onto eastbound SR518. Take SR518 to Burien, cross over SR509. Turn right at 1st Avenue South and go 2.3 miles north and find The Mitered Corner on the right side of the street.

August 1999

Annual Picnic

September 1999

14th – General Meeting – 7 PM

Larson Juhl – Seattle

28th – Board Meeting

October 1999

12th – General Meeting – 7 PM

Millennium Gallery – Redmond

November 1999

9th – General Meeting – 7 PM

Colorplak – Redmond

30th – Board Meeting

December 1999

No Meeting

January 2000

11th – General Meeting – 7 PM

TBA
Election of EPFG Officers



T. M. Taricco
P. O. Box 411
Redmond, Washington 98073-0411

ADDRESS CORRECTION REQUESTED

NEXT MEETING

May 11th – General Meeting – 7 PM

The Mitered Corner – Seattle
Pricing Round Table

ATTENTION: FRAME SHOP