

THE JUNE TRICKS

By Terry Scidmore, CPF - The Mitred Corner

The June meeting about tricks of the trade began with an animated discussion of filling nail holes in frames. Framers shared how putty, the traditional hole filler, can be blended by heating the putty in a microwave in a microwave able container. Putty can be easily applied and worked into cracks using rubber tipped clay working tools. Excess putty can be swept out of weathered or rough surfaces by using an old oil painting brush with the bristles cut short. Other framers shared their enthusiasm for spackle as a hole filler. The spackle is painted with acrylic paint that is mixed on a piece of scrap glass held over the frame so that the paint can be easily matched to the frame.

After filling corners, suggestions were made for getting good cuts, coloring the edge before joining, having pre-made frame and mat combinations, and using store art to

(Continued on page 3)

PRESIDENT'S LETTER

By Paul Knoop, the framemakers, Tacoma



It is sure hard to believe that the year is half over already; where has the time gone? As the saying goes, "Time flies when you are having fun", and I hope that you are still having fun in your business. One of the things that makes it fun for me is the challenge of doing something new, learning a new skill, and having the opportunity to have learn from others. This past month, the meeting was one of those times to pick up some tricks of the trade, and I learned several things to try.

July's meeting at Lake City Picture Framing promises to be another of those learning experiences which I hope that you can take advantage of. A special presentation of Fabric Mats will be presented by Frank Chavez, a long-time dealer in specialty fabrics for picture framing, and he brings a wealth of experience to share with us. It has been quite a while since we have had a program on custom wrapped mats, and if you haven't used this technique in your business, it really is a skill that all framers should have as a part of their repertoire. I am confident that we will be able to pick up some valuable help from Frank, and later we can build on his program with our in-house expertise to branch out to continuous covered liners, embossed fabrics, etc. Hope that you can make it.

(Continued on page 6)

INSIDE THIS ISSUE

CLASSIFIED ADS	5
"BATTER UP" FOR THE EPFG ANNUAL PICNIC	9
EVENTS CALENDAR	BACK



July 1999

Newsletter Cost: free to EPFG members, \$1.00 for non-members

Serving Alaska & Washington

THIS MONTH'S MEETING "FABRIC MATS"

The July meeting will be held at Lake City Picture Framing. The topic for the evening will be fabric mats. Frank Chavez of Frank's Fabrics will be our featured speaker. Frank has been involved in teaching the framing industry about fabric mats for many years, as well as supplying the fabrics for the mats. Bring another framer with you to enjoy this educational and informative meeting.

More information and directions to the meeting on the back.



"BATTER UP"
August 15th!



HOW TO CONTACT US

Membership Dues, Advertising Payments:

Kioski Toda, EPFG Treasurer
3058 Issaquah-Pine Lake Road
Issaquah, WA 98027
Phone: (425) 557.5494

Change of Address:

Nancy Chapman
15209 263 Ave. SE
Issaquah, WA 98027
Phone: (425) 392.7334
bimindesigns@hotmail.com

For changes of address please include old and new address information.

Classified Ad Copy, Display Ad Artwork:

Tim Taricco
P.O. Box 411
Redmond, WA 98073
Fax: (630) 839-4591
frameguy@myframeshop.com

Classified ads
Free for EPFG members, \$10 for non-members

Display Ad Artwork
Digital artwork is requested. PC format preferred / Mac format okay. Submit via e-mail or on disk.

Publishing Deadline
20th of the month prior to distribution.

1999 EPFG Officers

President

Paul Knoop, CPF
the framemakers
253.564.2320
pknoop@earthlink.net

Vice President

Donna Rickman, CPF
Finishing Touches
425.338.0932
rrickman@aol.com

Treasurer

Kiyoshi Toda, CPF
Accent On Framing
425.557.5494

Secretary

Terry Scidmore, CPF
The Mitered Corner
206.433.1145

Board Of Directors

Joe Garitone, CPF
Larson-Juhl
800.223.0307 x455

Joe Huber
Studio Moulding
800.262.4174 x217

Ben Edwards
Framers' Inventory
206.793.0613

Ray Miles
National Glass
800.521.7061

Past President

Frank Larson, CPF
Larson Fine Art Services
425.482.0549

The EPFG Newsletter is published monthly by Tim Taricco.
Mailing Address: P. O. Box 411 - Redmond, Washington 98073-0411. **Phone:** (425) 885-9730 **Fax:** (630) 839-4591
E-mail: frameguy@myframeshop.com **Web Site:** http://www.myframeshop.com/tradeonly/. Newsletter Design ©1999 T. M. Taricco and Newsletter Content ©1999 Evergreen Picture Framers Guild. All rights reserved. Do not duplicate or redistribute in any form.

Need Training for New Employees?

SEE WHAT YOUR DOLLAR CAN DO IN CANADA

The Canadian Picture Framers' School
#1, 20678 Duncan Way
Langley, B.C.

providing excellent thorough instruction in picture framing for over 10 years. Phone or fax for more info:
Ph: 604-533-5328
Fax: 604-533-9680

STUDIO MOULDING

8214-B South 192nd St., Kent, WA 98032

FREE FREIGHT
On all orders over \$100.00 in OR and WA

JOE HUBER Orders: (800) 262-4174
Voice Mail Ext: 217
Fax: (888) 423-1814

CORONA
1150 Industry Drive Tukwila, WA 98188
Division of RCI, Inc.

The choice of professionals, CORONA Cold & Hot/Cold Vacuum presses. Complete mounting/laminating supplies. Originators of BERTO and Corona Hot/Cold Unimount adhesives...the industry mainstays for over 20 years. 'The Mounting Specialists'.

Suppliers to the Picture Framing Industry for over 30 years

206.575.2727 Fax: 206.575.2667



Jeff Schuffman
Sales Representative

1433 W. Frankford Rd. #100 Carrollton, Texas 75007
972-466-0721 • 972-466-3662 Fax
800-527-0421 • 800-817-0524 Fax
Ext. 882



Wholesale Picture
Frame Supplies

2928 4th Ave S • Seattle, WA 98134
206-292-9664
800-423-6287

Software Suite for Windows 95 and earlier
Galleries & Frame shops Networking User Friendly!

FERENSOFT
TRIO!

- Art
- Customers
- Framing

Point of Sale and Business Management suite with optional WIZARD™ mat cutter link. See why people are switching to FS TRIO! Seattle 206-282-1775.



THE JUNE TRICKS

CONTINUED

(Continued from page 1)

help customers envision what will be done with their pictures. Conservation then turned to general business attitudes and determining what you want your business to be. Framers felt that it was important not to prejudge the customer or the art, and to focus on the best framing design for the piece. It was also important to be aware that not every piece a customer brings in requires top of the line framing. Pricing issues, always a popular topic, were brought up. About half of the framers were computerized at point of sale, but all framers were using computers to generate some information used in the business, whether in the form of charts, customer files, bookkeeping, signage, etc. Some framers express that well designed pricing charts were fast, accurate, and not difficult to update, while others felt their point of sale computer software was the equivalent of half an employee. The 1999 EPFG pricing survey results, handed out at the May meeting, is often the catalyst for a business to review its pricing and business plan. In the May issue of Décor, page 132 – 137, Rob Markoff, CPF, write about preparing a business plan in a simple to follow format. Check it out!

TRU VUE GLASS
FOR EVERYTHING YOU NEED

<p>PREMIUM SERIES GLASS</p> <ul style="list-style-type: none"> • PREMIUM CLEAR™ • REFLECTION CONTROL™ • AR™ REFLECTIVE FREE 	<p>CONSERVATION SERIES GLASS</p> <ul style="list-style-type: none"> • CONSERVATION CLEAR™ • CONSERVATION REFLECTION CONTROL™ • MUSEUM GLASS™
---------------------------------------------------------------------------------------------------------------------------------------------------------------------	--------------------------------------------------------------------------------------------------------------------------------------------------------------------------------------

10000 1st Ave. S. • Seattle, WA 98148
206-282-7000



The Hi-Lite is just another creative idea to offer your customers using Colorplak.

The Hi-Lite

425 / 883-1780

Image mounted on 1/4" board with bevel and edge. Then the board is mounted onto a ColorLite, ColorFloat or ColorBox with a Colormat.

NIELSEN & BAINBRIDGE

LINDA GARRETT
Regional Manager

Voice Mail: (800) 524-0434 Ext. 8433

6280 Artesia Blvd.
Buena Park, CA 90622

(800) 321-2934
Fax (714) 522-7890



PRADO™

Seven golden mouldings reminiscent of regal antiquity.

*For more information on Prado and other Larson-Juhl framing products call:
(216) 433-6002, (800) 627-1500 or (800) 438-5031*

or contact your Larson-Juhl sales representative

Voice Mail: 800-223-0307

Stephen Dean - ext. 454 • Paul Anderson - ext. 456 • Joe Garitone - ext. 455

LARSON · JUHL

ADDING ARTISTRY TO ART
WARMTH TO LIVING

NATIONAL GLASS

17030 WOODINVILLE-REDMOND ROAD, WOODINVILLE, WA. 98072

QUALITY PRODUCTS AND EXCELLENT SERVICE! NATIONAL GLASS
INVENTORIES THE LARGEST SELECTION OF PICTURE FRAMING GLASS IN THE PACIFIC
NORTHWEST.



NATIONAL GLASS

**TRU VUE AND SANDEL PREMIUM, REFLECTION CONTROL, SATINVIEW, CONSERVATION
SERIES GLASS, IMAGE PERFECT, DENGLAS, AND CRYSTALVIEW.**

Now Available - AR Glass & Museum Glass!

ALSO AVAILABLE: *FOAM-X*, MIRROR AND ACRYLICS

EVERYTHING YOU NEED AND *FREE DELIVERY* ARE ONLY A PHONE CALL AWAY!

(425) 488-8126

1 (800) 521-7061

fax (425) 488-3712



SEATTLE, WA 98133



THE ART DOCTOR
Restoration of Oil Paintings, Japanese Screens,
Art on Paper, Art Objects

NANCY G. WHITE (206) 783-9160
Restorer By Appointment

CLASSIFIED ADS

If you have something to sell, do it here!!! Classified ads are FREE for EPFG members and \$10 for non-members. This is just another benefit your \$40 membership fee gives you.

WILLIAMSON • FOAMCORE • TRUVUE GLASS/MILLER MATBOARD • CLARK DESIGNER WOOD & METAL • PIEDMONT • COLONIAL • BURNICH

TRUVUE CONSERVATION MATBOARD

Mention this ad and receive 10% OFF
when you order \$ or more
Any Color • Any Size

METAL FRAMES ART



6010 EAST ALKI WAREHOUSE #5
PHONE 800 344-7329 509 535-3440

SPOKANE WASHINGTON 99212
FAX 800 344-5003 509 535-3466



Pacific Framing Supply
"Serving all of your framing needs"

Brad Airhart & John Cave

Salem, OR 97304
Phone: 1-800-872-4445
FAX: 1-503-363-7273

Woodinville, WA 98072
Phone: 1-800-292-3202
FAX: 1-206-486-4978

It's About Choices...



Crescent Regular Matboard, with the greatest array of colors, is the **right choice** for everyday decorative framing. Crescent Whitecore Basics, with its non-yellowing white core, is the **ideal choice** for the design requirements of today's contemporary decor. Crescent Rag Mat remains the **only choice** for conservation framing. With its naturally 100% acid- and lignin-free cotton core, it's the premier choice for protecting priceless works of art and irreplaceable memories.



Crescent
WE GIVE YOU THE RIGHT CHOICES!
<http://www.crescent-cardboard.com>

Crescent Cardboard Company, 100 West Willow Road, Wheeling, Illinois 60090, Tel. 1-847-537-3400, Fax 1-847-537-7153

- **FRAME SHOP & GALLERY FOR SALE** – Owner retiring from 22 year established, award winning shop in the growing community of Silverdale, WA. Full framing equipment, art and staff available. Lease and terms ready to sell. Large customer base will growing professional clientele. Call 360/697-1021 message.
- **DONATE** left over wood moulding, scrap matboard, and glass for financially challenged children's art projects. Will pick up. Art Shack 425/788-7166.
- **FRAME EQUIPMENT FOR SALE** – 48"x70" cold vacuum press, seals posters in 25 seconds, \$700. All steel oval mat cutter with table, \$700. Two metal display racks with rubber casters for easy arranging posters, \$45 each. Phaedra double miter system (NEW), \$350. Five 30"x72" folding tables, \$25 each and two with rubber casters, \$85 each. Two Boeing drafting tables, \$60 each. Six fabric covered boards for corner samples, \$15 each. FREE stuff: filing cabinets, over stuffed chair. All items are subject to OBO. 206/860-1745 or fax 206/860-2174.
- **SMALL FRAME SHOP FOR SALE** – Interested in owning your own business? King's Custom Frames in Port Orchard is for sale. Contact Bonnie at 360/876-8849.
- **FRAME SHOP FOR SALE:** Health forces immediate sale. After 28 years, The Frame Up at Totem Lake has a year and a half left on its lease, with an option. \$25,000 buys complete inventory: chopper, joiner, metal saw, mat cutter, oval master, glass cutter, vacuumount machine, heat press, work tables, print bins, framed prints, hundreds of ready made frames, many commercial accounts, as well as 28 years of clientele. Average year 90 to 100 thousand and growing. Great opportunity for anyone wanting to pursue a career in this field. Contact Dyann Webb 425/821-1331 or 425/823-8286.
- **EQUIPMENT FOR SALE:** 40 x 60 Corona Vacuum Press, complete \$600. C&H 60" Pro Wall Cutter, like new \$800. Fletcher 2100 40" mat cutter w/ production stops, \$600. Eight department cash register, new \$80. Zon Jr. XL credit card terminal, \$150. To view the equipment, call Philip at 206/281-0054.



FI FRAMERS' INVENTORY

NOW OPEN IN SEATTLE!

WOOD MOULDING
Arquati, Bay, Framers' Inventory,
LaMarche, Max, Roma, Williamson

METAL MOULDING
Nielsen

MATBOARD
Bainbridge, Crescent, Tru Vue

GLASS & FOAMBOARD
True Vue, Sandel,
Bienfang, Bainbridge

EQUIPMENT
C&H, Fletcher
Seal Mounting

SERVICE
Daily delivery in the
Portland & Seattle Metro areas
Will call open til 6:00 PM
Overnight chop service

FI

4412 4TH AVENUE SOUTH, SEATTLE WA 98143
5000 SE 18TH AVENUE, PORTLAND, OREGON 97202
TOLL FREE (800)543-2467 FAX (503)238-3899

VICTOR
MOULDING COMPANY

Have You Seen?

Southern Comfort Line
Hunt Club Line
Impasto Line
Tiburon Line

IF YOU HAVEN'T, CALL YOUR SALES
REPRESENTATIVE TODAY!

1-800-359-2829

Chuck Bigford Ext. 3715

VM
3439 S.W. BOND
PORTLAND, OREGON 97201
Jim Jillard - Branch Manager

PRESIDENT'S LETTER CONTINUED

(Continued from page 1)

Last month, I was invited to attend the PPFA Chapter Leader's Academy in Chicago, and took advantage of that opportunity to gather further information concerning the "health" of the National organization. I did this in an effort to advise the Board and you of the direction our organization should take regarding chapter affiliation. I feel that this is an important issue to us, and deserves considerable study and research. This meeting provided me the opportunity for just such research, and it was valuable to gather information from Officers of the regional Chapters as well as hear first hand from the National leadership how they feel about the progress made (and still to go) to regain the confidence of the industry they serve. While PPFA is not completely out of the woods yet financially, considerable progress has been made in eliminating the debts which were one of the reasons for our decision to withdraw. The new leadership is very positive in

their approach, they listen to what the members are saying, and are very open to suggestions. In short, all good signs for the future. We are exploring the possibility of inviting the Executive Director to one of our meetings this fall to give us a first-hand account of their progress and to answer your specific questions. Stay tuned to this, it is important.

One final note to put on your planning calendar now is the August meeting, our annual Guild outing. Past years have featured picnics, games, and fun competitions designed to be family events. This year is no exception. While some of the details are yet to be worked out, EPFG members who attend will have an unusual experience. Several options are in the works, so stay tuned, and by the way, if you have not yet joined, now would be the perfect opportunity to do so, and take advantage of all we have to offer. Contact Nancy Chapman for dues schedule, membership brochure, etc.

Paul Knoop
EPFG President



HARTUNG
GLASS INDUSTRIES

Hartung Glass was the first company in the Northwest Region to deliver to the Picture Framing Industry. We have been serving the Picture Framers in our area for over twenty years and offer the largest inventory of stock sheets in the Pacific Northwest. We feature all of the top manufacturers, including Sandel, Tru-Vue, and Cyro, with scheduled deliveries to most areas of Washington. We carry many types of framing glass, including:

- | | |
|-----------------|--------------------|
| Clear | Sandel Superior |
| Anti-Reflection | Sandel Crystalview |
| Non-Glare | Tru-Vue & Sandel |
| Conservation | Tru-Vue |
| Preservation | Sandel |
| Museum Glass | Tru-Vue |

Call today to schedule a delivery!

**Hartung now stocks
3/16 mirror with 1" bevel for framing.
Call our helpful customer Service Department today to place your order!**

**425/656-2626
800/552-2227**

**Chances are you started out with a LOGAN Mat Cutter
Have you seen what we've done lately?**

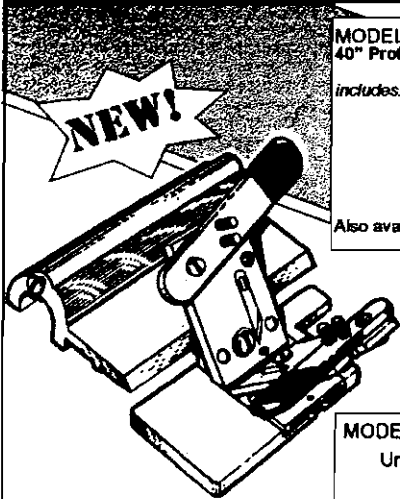

Model 705
Logan
V-Groover

MODEL #650 *Framer's Edge* MAT CUTTER
40" Professional Production Matcutter

- includes:
- Ergonomically designed Dual straight and Bevel cutting head
 - Production Stops
 - Parallel Mat Guide
 - Start and Stop Indicator for line to line cutting.
 - 27" Squaring Arm

Suggested List Price \$599.95

Also available in a 60" version MODEL #660 *Framer's Edge* \$799.95

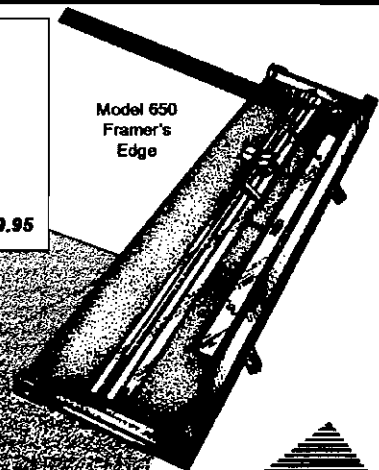

Model 650
Framer's
Edge

MODEL 705 LOGAN V-Groover patented

Unique "push-pull" surface V-Groover that cuts beautiful V-Grooves on the surface of the matboard. Works entirely with stops provided for accurate V-Grooving in seconds with zero overcuts. Endless creative possibilities!!

Suggested List Price \$125.00

MODEL 706 Universal V-Groover patented

Works on professional mat cutters using a 5/8" thick cutting bar rod including Fletcher® and C&H® professional matcutters.

Suggested List Price \$150.00



GRAPHIC PRODUCTS, INC.
1100 BROWN STREET • WAUCONDA, ILLINOIS 60084
NATION-WIDE TOLL FREE 1-800-231-6222
TOLL FREE FAX 800/231-4329

See us at <http://www.artproducts.com>
E-MAIL: Logan-Graphic-Products@worldnet.att.net



6001 Santa Monica Boulevard, Los Angeles, California 90038
Tel # (213) 469-9006 • Fax # (213) 469-0940
World Wide Web: <http://www.FramingFabrics.com> • E-mail: info@ffmi.com

New Pre-Covered Lip Liner

Ask about our
Distributors Discount.

Expanded Liner Selection

Framing Fabrics & Moulding International is very happy to introduce **NEW LINERS**. With the recent expansion of our liner offerings, we are able to provide our customers with a complete liner selection, at very competitive prices. These seven new additions include a flat profile in two sizes, a bevel profile in two sizes and a scoop profile in three sizes, all with hand-finished lips of bright gold, antique gold and antique silver. These lip liners are available in four fabrics, 100% BELGIQUE Natural Linen; Union Blend of MANHASSET Natural and Oyster and Antique Satin MARQUIS Black.

LIP FINISHES

Bright Gold ❖ Antique Gold ❖ Antique Silver

FABRICS

Manhassel Natural ❖ Manhassel Oyster
Belgique Natural ❖ Marquis Black

All are pre-covered. However, we are also able to meet most of your custom needs (*Custom Wraps*), just call and ask our Customer Service Department personnel. Upon request, we can cover our lip liners with any of the 500 fabrics we sell. A 50 ft. minimum applies to liners cut to 6 & 4 or 5 & 5 ft. lengths; a 100 ft. is required on liners in standard 10 ft. lengths.

These liners are in addition to the original thirty liner profiles we offer in Primed, Pre-covered and *Custom Wrapped* both in length and chop.

FLAT

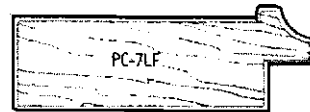
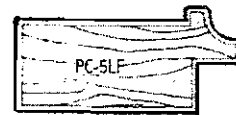

BEVEL

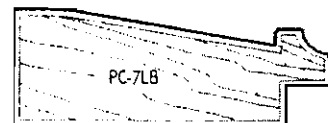
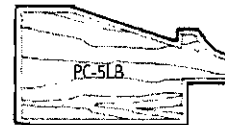

SCOOP

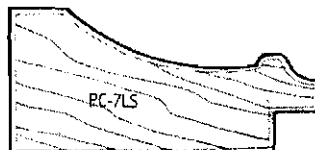
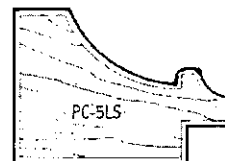

Shown Actual Size



"BATTER UP" FOR THE EPFG ANNUAL PICNIC

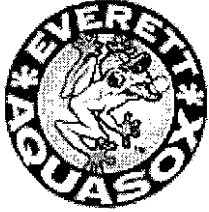

"Take me out to the ball game, take me out with the crowd. Buy me some peanuts and cracker jacks...." Oops! You really don't want to hear me sing, but we can cheer the Everett Aquasox together at the EPFG picnic & ball game Sunday August 15. The Aquasox are a farm team of the Mariners so we

can see the stars of the future close up and personal in their new stadium. An all- you-can-eat-picnic with chicken, hot dogs, hamburgers, salads, chips and pop, is planned for 1PM with the first pitch at 2PM. The picnic area is under covered so don't let any *Seattle* sunshine change your plans. The cost is only \$18.00 per adult, \$13.00 for kids 3-12 years, younger are free, for the picnic, baseball and parking. This is a great family event so call Donna Rickman at (425)338-0932 for reservations by **August 5th**.

Directions to the New Everett Memorial Stadium are from either I-5 north or south take the Broadway (exit 192) in Everett with the stadium at 3802 Broadway.

UNIVERSAL Framing Products

Edgar Solares
Account Representative
Telephone • 206-440-1545

9415 Telfair Avenue • Sun Valley CA 91352
Telephone • 818-767-8700 • 800-668-3627

Fabric & Liners

The Other Side of Framing

Hundreds of colors and textures --- Exclusive pH Neutral Fabrics

Frank's

Fabrics for Framers

Dial Toll-Free (888) F.FABRIX (332-2749)

NURRE CAXTON

FRAMES OF DISTINCTION



*"We're Obsessed
With Customer
Satisfaction"*

Pamela Neal

Sales Representative for
Washington, Wyoming, Montana
Oregon and Idaho

1-800-255-1942, press 6, ext. 4011
for voice mail

1-800-377-3300 fax

1-800-910-8966 pager

We promise friendly, reliable service,
same day chop service, free UPS
for orders of 3 chops or more
(wood and Nielsen metal combined)

July 1999
13th – General Meeting – 7 PM
Lake City Picture Framing – Seattle
Fabric Mats
27th – Board Meeting

August 1999
15th – Annual Picnic – 1 PM
Everett Aquasox Baseball
New Everett Memorial Stadium

September 1999
14th – General Meeting – 7 PM
Larson Juhl – Seattle
19th – CPFG Trade Show
Doubletree Inn, Vancouver, WA
28th – Board Meeting

DIRECTIONS TO THE MEETING
Lake City Picture Framing
14028 Lake City Way
Seattle – (206) 363-2100

Coming from North of Seattle – Take the 145th Street exit off I-5 and go East to Lake City Way NE. Turn right and look for Lake City Picture Framing on the left.

Coming from South of the University District – Take the Lake City Way exit off I-5. Take Lake City Way to the North side of Lake City where you will find Lake City Picture Framing on your right.

Coming from the Eastside – Take 520 to I-5 and follow the directions above OR take the Bothell exit off I-405 and take Bothell Way around the North end of the lake. When Bothell Way hits 145th, it changes to Lake City Way. Look for Lake City Picture Framing on your left.

October 1999
12th – General Meeting – 7 PM
Millennium Gallery – Redmond

November 1999
9th – General Meeting – 7 PM
Colorplak – Redmond
30th – Board Meeting

December 1999
No Meeting

January 2000
11th – General Meeting – 7 PM
TBA
Election of EPFG Officers

February 2000
8th – General Meeting – 7 PM
TBA

March 2000
Annual Spring Festival
Election of EPFG Officers



T. M. Taricco
P. O. Box 411
Redmond, Washington 98073-0411

ADDRESS CORRECTION REQUESTED

NEXT MEETING

July 13th – General Meeting – 7 PM

Lake City Picture Framing – Seattle
Fabric Mats

ATTENTION: FRAME SHOP