

A HOT SUMMER NIGHT

By Terry Scidmore, CPF - The Mitred Corner

It was a hot July night on Lake City Way. Frank Chavez and his fabrics stopped by to relay how fabric mats and liners from synthetic to silk can increase your profit as cream enriches milk.

Frank showed all attending which glue held the best, and special techniques for your fingers to test. He emphasized the variety of creative endeavors to impress your customers and fluff up your feathers. He demonstrated laying fabric on liners and mats and how to ensure that the fabric lays flat. Frank pointed out fabrics dimensional quality with colors and texture for designing totality. The value the customer sees in its richness entices them to exclaim "Yes, by George, I will get this!"

The EPFG will bring you more in the fall when Larry and Kiyoshi will share all about embossed mats, fabric v-grooves, and secrets galore, to perk up your designs and increase sales for your store!

PRESIDENT'S LETTER

By Paul Knoop, the framemakers, Tacoma



Several months ago, I promised an update on the information gained from my recent meeting with Officers from PPFA and Chapter leaders in Chicago, so here goes an attempt to condense 5 pages of my notes and 6 pages from PPFA. My main objective was to gather information about the benefits, if any, to our organization by affiliation with the National organization. While there are many benefits to an individual business, and PPFA is very good at explaining them, at the Chapter level things are not nearly so clear cut, and little time has been spend defining these benefits, or advantages to affiliation.

First and foremost, I would have to list the opportunity to meet with other Officers and Board members and share ideas, common problems and their solutions, and very importantly, let the National leadership know what we need and want. Granted there is a "one member, one vote" policy, but I know that the PPFA Board and the Executive Director will listen very carefully to what the Chapters are saying; after all, they speak with a collective voice for their entire membership. If changes are needed or desired, they must be effected from inside, not outside the organization.

(Continued on page 7)

INSIDE THIS ISSUE

SUMMER PICNIC INFORMATION	3
CLASSIFIED ADS	5
EVENTS CALENDAR	BACK



August 1999

Newsletter Cost: free to EPFG members, \$1.00 for non-members

Serving Alaska & Washington

THIS MONTH'S MEETING



"BATTER UP!"
August 15th!

"Take me out to the ball game, take me out with the crowd. Buy me some peanuts and cracker jacks...." Oops! You really don't want to hear me sing, but we can cheer the Everett Aquasox together at the EPFG picnic & ball game Sunday August 15.

NOTE FROM THE EDITOR

Sorry for the delay in receiving the August EPFG newsletter. This entire newsletter is published on a computer each month and last week it decided to crash. Everything is up and running again now.



HOW TO CONTACT US

Membership Dues, Advertising Payments:

Kioski Toda, EPFG Treasurer
3058 Issaquah-Pine Lake Road
Issaquah, WA 98027
Phone: (425) 557.5494

Change of Address:

Nancy Chapman
15209 263 Ave. SE
Issaquah, WA 98027
Phone: (425) 392.7334
biminidesigns@hotmail.com

For changes of address please include old and new address information.

Classified Ad Copy, Display Ad Artwork:

Tim Taricco
P.O. Box 411
Redmond, WA 98073
Fax: (630) 839-4591
frameguy@myframeshop.com

Classified ads
Free for EPFG members, \$10 for non-members

Display Ad Artwork
Digital artwork is requested. PC format preferred / Mac format okay. Submit via e-mail or on disk.

Publishing Deadline
20th of the month prior to distribution.

1999 EPFG Officers

President
Paul Knoop, CPF
the framemakers
253.564.2320
pknoop@earthlink.net

Vice President
Donna Rickman, CPF
Finishing Touches
425.338.0932
rickman@aol.com

Treasurer
Kiyoshi Toda, CPF
Accent On Framing
425.557.5494

Secretary
Terry Scidmore, CPF
The Mitered Corner
206.433.1145

Board Of Directors
Joe Garitone, CPF
Larson-Juhl
800.223.0307 x455

Joe Huber
Studio Moulding
800.262.4174 x217

Ben Edwards
Framers' Inventory
206.793.0613

Ray Miles
National Glass
800.521.7061

Past President
Frank Larson, CPF
Larson Fine Art Services
425.482.0549

The EPFG Newsletter is published monthly by Tim Taricco.
Mailing Address: P. O. Box 411 - Redmond, Washington 98073-0411. **Phone:** (425) 885-9730 **Fax:** (630) 839-4591
E-mail: frameguy@myframeshop.com **Web Site:** <http://www.myframeshop.com/tradeonly/>. Newsletter Design ©1999 T. M. Taricco and Newsletter Content ©1999 Evergreen Picture Framers Guild. All rights reserved. Do not duplicate or redistribute in any form.

Need Training for New Employees?

SEE WHAT YOUR DOLLAR CAN DO IN CANADA

The Canadian Picture Framers' School
#1, 20678 Duncan Way
Langley, B.C.

providing excellent thorough instruction in picture framing for over 10 years. Phone or fax for more info:
Ph: 604-533-5328
Fax: 604-533-9680

STUDIO MOULDING

8214-B South 192nd St., Kent, WA 98032

FREE FREIGHT
On all orders over \$100.00 in OR and WA

JOE HUBER Orders: (800) 262-4174
Voice Mail Ext: 217
Fax: (888) 423-1814

 **CORONA** 
1150 Industry Drive Tukwila, WA 98188
Division of RCI, Inc.

The choice of professionals, CORONA Cold & Hot/Cold Vacuum presses. Complete mounting/laminating supplies. Originators of BERTO and Corona Hot/Cold Unimount adhesives..the industry mainstays for over 20 years. 'The Mounting Specialists'.

Suppliers to the Picture Framing Industry for over 30 years

206.575.2727 Fax: 206.575.2667



Jeff Schuffman
Sales Representative

1433 W. Frankford Rd. #100 Carrollton, Texas 75007
972-466-0721 • 972-466-3662 Fax
800-527-0421 • 800-817-0524 Fax
Ext. 882



2928 4th Ave S • Seattle, WA 98134
206-292-9664
800-423-6287

Wholesale Picture
Frame Supplies

Software Suite for Windows 95 and earlier
Galleries & Frame shops Networking User Friendly!

FERENSOFT
TRIO!

- Art
- Customers
- Framing

Point of Sale and Business Management suite with optional WIZARD™ mat cutter link. See why people are switching to FS TRIO! Seattle 206-282-1775.



DON'T FORGET THE EPFG ANNUAL SUMMER PICNIC



"Take me out to the ball game, take me out with the crowd. Buy me some peanuts and cracker jacks...." Oops! You really don't want to hear me sing, but we can cheer the Everett Aquasox together at the EPFG picnic & ball game Sunday August 15. The Aquasox are a farm team of the Mariners so we can see the stars of the future

close up and personal in their new stadium. An all-you-can-eat-picnic with chicken, hot dogs, hamburgers, salads, chips and pop, is planned for 1PM with the first pitch at 2PM. The picnic area is under covered so don't let any Seattle sunshine change your plans. The cost is only \$18.00 per adult, \$13.00 for kids 3-12 years, younger are free, for the picnic, baseball and parking. This is a great family event so call Donna Rickman at (425)338-0932 for reservations by **August 5th**.

TRU VUE GLASS
FOR EVERY REPAIRING NEED

<p>PREMIUM SERIES GLASS</p> <ul style="list-style-type: none"> • PREMIUM CLEAR* • REFLECTION CONTROL* • AR* REFLECTIVE FREE 	<p>CONSERVATION SERIES GLASS</p> <ul style="list-style-type: none"> • CONSERVATION CLEAR* • CONSERVATION REFLECTION CONTROL* • MUSEUM GLASS*
---	--

206-282-1775



425 / 883-1780 800 / 305-1953

Colorplak dealers experience quick delivery time because of our fabulous service! Colorplak dealers can receive a pick-up twice a week! Are you a Colorplak dealer?

Directions to the New Everett Memorial Stadium are from either I-5 north or south take the Broadway (exit 192) in Everett with the stadium at 3802 Broadway.



PRADO™

Seven golden mouldings reminiscent of regal antiquity.

For more information on Prado and other Larson-Juhl framing products call:
(216) 433-6002, (800) 627-1500 or (800) 438-5031

or contact your Larson-Juhl sales representative

Voice Mail: 800-223-0307

Stephen Dean - ext. 454 • Paul Anderson - ext. 456 • Joe Garitone - ext. 455

LARSON · JUHL

ADDING ARTISTRY TO ART
WARMTH TO LIVING

NATIONAL GLASS

17030 WOODINVILLE-REDMOND ROAD, WOODINVILLE, WA. 98072

QUALITY PRODUCTS AND EXCELLENT SERVICE! NATIONAL GLASS
INVENTORIES THE LARGEST SELECTION OF PICTURE FRAMING GLASS IN THE PACIFIC
NORTHWEST.



NATIONAL GLASS

**TRU VUE AND SANDEL PREMIUM, REFLECTION CONTROL, SATINVIEW, CONSERVATION
SERIES GLASS, IMAGE PERFECT, DENGLAS, AND CRYSTALVIEW.**

Now Available - AR Glass & Museum Glass!

ALSO AVAILABLE: *FOAM-X*, MIRROR AND ACRYLICS

EVERYTHING YOU NEED AND *FREE DELIVERY* ARE ONLY A PHONE CALL AWAY!

(425) 488-8126

1 (800) 521-7061

fax (425) 488-3712



SEATTLE, WA 98133



THE ART DOCTOR

Restoration of Oil Paintings, Japanese Screens,
Art on Paper, Art Objects

NANCY G. WHITE
Restorer

(206) 783-9160
By Appointment

WILLIAMSON • FOAMCORE • TRUVUE GLASS/MILLER MATBOARD • CLARK
DESIGNER WOOD & METAL • PIEDMONT • COLONIAL • BURNICH

**MFA PRESENTS
THE DESIGNER WOODS**

"Purity Collection"

Featuring deep, rich wood grain veneers that exude warmth and
nature. Choose from three profiles and seven real wood veneers.

METAL FRAMES ART



6010 EAST ALKI WAREHOUSE #5
PHONE 800 344-7329 509 535-3440

SPOKANE WASHINGTON 99212
FAX 800 344-5003 509 535-3466



Pacific Framing Supply

"Serving all of your framing needs"

Brad Airhart & John Cave

Salem, OR 97304
Phone: 1-800-872-4445
FAX: 1-503-363-7273

Woodinville, WA 98072
Phone: 1-800-292-3202
FAX: 1-206-486-4978

It's About Choices...



Crescent Regular Matboard, with the greatest array of colors, is the **right choice** for everyday decorative

framing. Crescent Whitecore Basics, with its non-yellowing white core, is the **ideal choice** for the

design requirements of today's contemporary decor. Crescent Rag Mat remains the **only choice** for conservation framing.

With its naturally 100% acid- and lignin-free core, it's the premier choice for protecting priceless works
of art and irreplaceable memories.



Crescent

We Give You THE RIGHT CHOICES!
<http://www.crescent-cardboard.com>

Crescent Cardboard Company, 100 West Willow Road, Wheeling, Illinois 60090, Tel. 1-847-537-3400, Fax 1-847-537-7153

CLASSIFIED ADS

If you have something to sell, do it here!!! Classified ads are FREE for EPFG members and \$10 for non-members. This is just another benefit your \$40 membership fee gives you.

- **FRAME SHOP & GALLERY FOR SALE** – Owner retiring from 22 year established, award winning shop in the growing community of Silverdale, WA. Full framing equipment, art and staff available. Lease and terms ready to sell. Large customer base will growing professional clientele. Call 360/697-1021 message.
- **DONATE** left over wood moulding, scrap matboard, and glass for financially challenged children's art projects. Will pick up. Art Shack 425/788-7166.
- **FRAME EQUIPMENT FOR SALE** – 48"x70" cold vacuum press, seals posters in 25 seconds, \$700. All steel oval mat cutter with table, \$700. Two metal display racks with rubber casters for easy arranging posters, \$45 each. Phaedra double miter system (NEW), \$350. Five 30"x72" folding tables, \$25 each and two with rubber casters, \$85 each. Two Boeing drafting tables, \$60 each. Six fabric covered boards for corner samples, \$15 each. FREE stuff: filing cabinets, over stuffed chair. All items are subject to OBO. 206/860-1745 or fax 206/860-2174.
- **SMALL FRAME SHOP FOR SALE** – Interested in owning your own business? King's Custom Frames in Port Orchard is for sale. Contact Bonnie at 360/876-8849.
- **FRAME SHOP FOR SALE:** Health forces immediate sale. After 28 years, The Frame Up at Totem Lake has a year and a half left on its lease, with an option. \$25,000 buys complete inventory: chopper, joiner, metal saw, mat cutter, oval master, glass cutter, vacuumount machine, heat press, work tables, print bins, framed prints, hundreds of ready made frames, many commercial accounts, as well as 28 years of clientele. Average year 90 to 100 thousand and growing. Great opportunity for anyone wanting to pursue a career in this field. Contact Dyann Webb 425/821-1331 or 425/823-8286.
- **EQUIPMENT FOR SALE:** C&H 60" Pro Wall Cutter, like new \$800. Fletcher 2100 40" mat cutter w/ production stops, \$600. Eight department cash register, new \$80. Zon Jr. XL credit card terminal, \$150. To view the equipment, call Philip at 206/281-0054.



FI *FRAMERS' INVENTORY*

NOW OPEN IN SEATTLE!

WOOD MOULDING

Arquati, Bay, Framers' Inventory,
LaMarche, Max, Roma, Williamson

METAL MOULDING

Nielsen

MATBOARD

Bainbridge, Crescent, Tru Vue

GLASS & FOAMBOARD

True Vue, Sandel,
Bienfang, Bainbridge

EQUIPMENT

C&H, Fletcher
Seal Mounting

SERVICE

Daily delivery in the
Portland & Seattle Metro areas
Will call open til 6:00 PM
Overnight chop service



4412 4TH AVENUE SOUTH, SEATTLE WA 98143
5000 SE 18TH AVENUE, PORTLAND, OREGON 97202
TOLL FREE(800)543-2467 FAX(503)238-3899

VICTOR
MOULDING COMPANY

Have You Seen?

Southern Comfort Line

Hunt Club Line

Impasto Line

Tiburon Line

IF YOU HAVEN'T, CALL YOUR SALES
REPRESENTATIVE TODAY!

1-800-359-2829

Chuck Bigford Ext. 3715



3439 S.W. BOND
PORTLAND, OREGON 97201

Jim Jillard - Branch Manager

HARTUNG
GLASS INDUSTRIES

Hartung Glass was the first company in the Northwest Region to deliver to the Picture Framing Industry. We have been serving the Picture Framers in our area for over twenty years and offer the largest inventory of stock sheets in the Pacific Northwest. We feature all of the top manufacturers, including Sandel, Tru-Vue, and Cyro, with scheduled deliveries to most areas of Washington. We carry many types of framing glass, including:

- | | |
|-----------------|--------------------|
| Clear | Sandel Superior |
| Anti-Reflection | Sandel Crystalview |
| Non-Glare | Tru-Vue & Sandel |
| Conservation | Tru-Vue |
| Preservation | Sandel |
| Museum Glass | Tru-Vue |

Call today to schedule a delivery!

***Hartung now stocks
3/16 mirror with 1"
bevel for framing.
Call our helpful cus-
tomer Service De-
partment today to
place your order!***

**425/656-2626
800/552-2217**



PRESIDENT'S LETTER CONTINUED

(Continued from page 1)

After only 1 1/2 days with other leaders, I came away more enthusiastic for my job, and with a wealth of ideas to try for improving our programs, attendance, meeting topics, etc. There is also an on-line Chapter Leader's Forum where Officers can share ideas and seek help from peers which we cannot presently take advantage of. There is a Chapter Leaders Manual, filled with good information concerning programs, educational materials, advertising, legal issues, etc. which is made available to all Officers and Board members.

Coming soon from National will be newsletter articles which we could use, and program materials and support for our monthly programs. Both of these items are things we asked for in the past, and lack of them was a factor considered in our withdrawing from PPFA.

PPFA will also provide distribution of our newsletter to all other Chapter officers, and vice versa, which would be a savings to our organization. Membership records can be maintained, and mailing labels provided for our mailings to

members, another potential cost and time saving.

At the Chapter Leaders Workshop, suppliers had provided approximately \$1,000 worth of giveaways, which ranged from pencils and pens to 10 new ATG guns, point drivers, tapes, etc. These would provide a source of no-cost door prizes for our meetings.

International exposure for our Guild via the publication "For Members Only", as well as the online forum and the PPFA web site (which, by the way, is being completely revised).

These are just a few of the items I have hit on as advantages for us at the Chapter level. I am sure there are others, and hopefully we will find out about some others as we continue our information gathering. We are going to explore having someone from the National organization join us for one of our meetings, and you will have a chance to see for yourself what's going on. Your thoughts on this matter are needed!!!

Paul Knoop
EPFG President

Chances are you started out with a LOGAN Mat Cutter Have you seen what we've done lately?

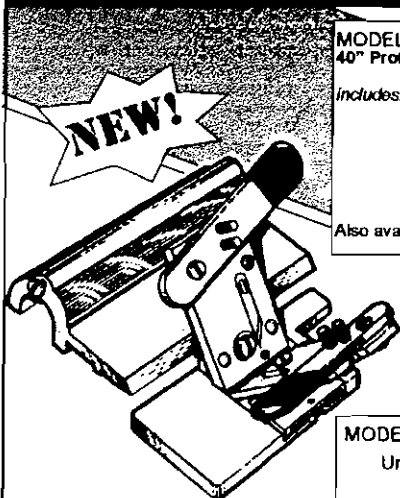

Model 705
Logan
V-Groover

MODEL #650 Framer's Edge MAT CUTTER
40" Professional Production Matcutter

- Includes:*
- Ergonomically designed Dual straight and Bevel cutting head
 - Production Stops
 - Parallel Mat Guide
 - Start and Stop Indicator for line to line cutting.
 - 27" Squaring Arm

Suggested List Price \$599.95

Also available in a 60" version MODEL #660 Framer's Edge \$799.95

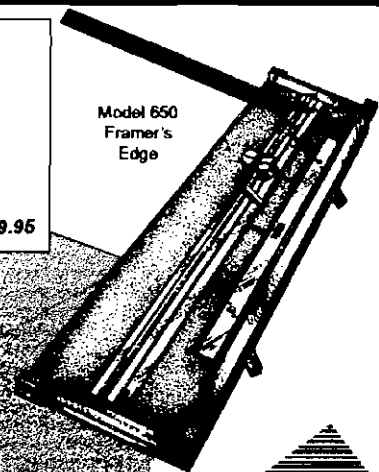

Model 650
Framer's
Edge

MODEL 705 LOGAN V-Groover patented

Unique "push-pull" surface V-Groover that cuts beautiful V-Grooves on the surface of the matboard. Works entirely with stops provided for accurate V-Grooving in seconds with zero overcuts. Endless creative possibilities!!

Suggested List Price \$126.00

MODEL 706 Universal V-Groover patented

Works on professional mat cutters using a 5/8" thick cutting bar rod including Fletcher® and C&H® professional matcutters.

Suggested List Price \$150.00



1100 BROWN STREET • WALKONDA, ILLINOIS 60084
NATIONWIDE TOLL FREE 1-800-331-6232
TOLL FREE FAX 800/331-6229

See us at <http://www.artproducts.com>

or email Logan-Graphic-Products@worldnet.att.net



6001 Santa Monica Boulevard, Los Angeles, California 90038
Tel # (213) 469-9006 • Fax # (213) 469-0940
World Wide Web: <http://www.FramingFabrics.com> • E-mail: info@ffmi.com

New Pre-Covered Lip Liner

Ask about our
Distributors Discount.

Expanded Liner Selection

Framing Fabrics & Moulding International

is very happy to introduce NEW LINERS. With the recent expansion of our liner offerings, we are able to provide our customers with a complete liner selection, at very competitive prices. These seven new additions include a flat profile in two sizes, a bevel profile in two sizes and a scoop profile in three sizes, all with hand-finished lips of bright gold, antique gold and antique silver. These lip liners are available in four fabrics, 100% BELGIQUE Natural Linen; Union Blend of MANHASSET Natural and Oyster and Antique Satin MARQUIS Black.

LIP FINISHES

Bright Gold ❖ Antique Gold ❖ Antique Silver

FABRICS

Manhasset Natural ❖ Manhasset Oyster
Belgique Natural ❖ Marquis Black

All are pre-covered. However, we are also able to meet most of your custom needs (*Custom Wraps*), just call and ask our Customer Service Department personnel. Upon request, we can cover our lip liners with any of the 500 fabrics we sell. A 50 ft. minimum applies to liners cut to 6 & 4 or 5 & 5 ft. lengths; a 100 ft. is required on liners in standard 10 ft. lengths.

These liners are in addition to the original thirty liner profiles we offer in Primed, Pre-covered and *Custom Wrapped* both in length and chop.

FLAT

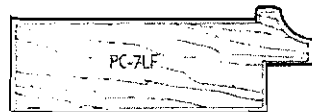
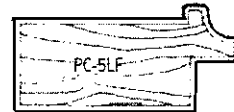

BEVEL

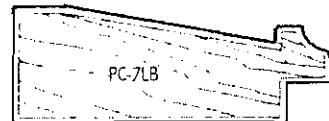
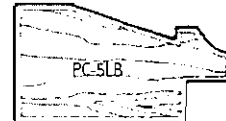

SCOOP

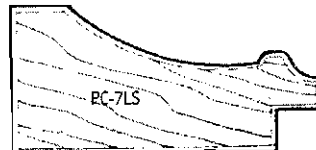
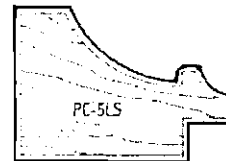

Shown Actual Size



NURRE CAXTON
FRAMES OF DISTINCTION

 *"We're Obsessed
With Customer
Satisfaction"*

Pamela Neal
Sales Representative for
Washington, Wyoming, Montana
Oregon and Idaho

1-800-255-1942, press 6, ext. 4011
for voice mail
1-800-377-3300 fax
1-800-910-8966 pager

We promise friendly, reliable service...
same day chop service free UPS
for orders of 3 chops or more
(wood and Nielsen metal combined)



Edgar Solares
Account Representative
Telephone • 206-440-1545

9415 Telfair Avenue • Sun Valley CA 91352
Telephone • 818-767-8700 • 800-668-3627

Fabric & Liners

The Softer Side of Framing

Hundreds of colors and textures --- Exclusive pH Neutral Fabrics

 **Fabrics for Framers**

Dial Toll-Free (888) F.FABRIX (332-2749)



REMINDER NOTE

Membership to the EPFG only costs \$40 per year.
Membership through the end of 1999 is currently
available for \$20.

Become a member today by sending a check payable to
EPFG to:

Nancy Chapman
15209 263 Ave. SE
Issaquah, WA 98027
Phone: (425) 392.7334
biminidesigns@hotmail.com

Join EPFG

August 1999

15th – Annual Picnic – 1 PM
Everett Aquasox Baseball
New Everett Memorial Stadium

September 1999

14th – Adv. Fabric Mats – 7 PM
Larson Juhl – Seattle
19th – CPFG Trade Show
Doubletree Inn, Vancouver, WA
28th – Board Meeting

October 1999

12th – Art History – 7 PM
Millennium Gallery – Redmond

**DIRECTIONS
TO THE MEETING**

Directions to the New Everett Memorial Stadium are from either I-5 north or south take the Broadway (exit 192) in Everett with the stadium at 3802 Broadway.

November 1999

9th – PPFA Discussion – 7 PM
Colorplak – Redmond
30th – Board Meeting

December 1999

No Meeting

January 2000

11th – General Meeting – 7 PM

February 2000

8th – General Meeting – 7 PM

March 2000

Annual Spring Festival
Election of EPFG Officers

April 2000

11th – General Meeting – 7 PM



T. M. Taricco
P. O. Box 411
Redmond, Washington 98073-0411

ADDRESS CORRECTION REQUESTED

ATTENTION: FRAME SHOP

98139+2242

