OUR PRESIDENT'S PEN

BY PAUL KNOOP, EPFG PRESIDENT



As I write this note, knowing that my computer is compliant this year, and wondering as many others are about what Y2K will bring, I am reminded of all the good things which have happened during the past year, and how much they outweigh those few bad things, or more interestingly, those few irritating customers with whom we have had to deal. Surely 2000 will bring just as many good memories, and fewer bad, if we just focus on the good and ignore the irritants.

This year's first meeting will be special, in that we all wish a fond farewell to one of our long-time members and a friend of the Guild, Jack Mergens of Hartung Glass. Jack has served our industry well and faithfully for many years, and I hope that many of you can take a few minutes to stop by and say goodbye to him. Jack, we wish you all of the best, and many happy years in retirement!!!

EPFG members should shortly receive a ballot for the election of Officers and Board members to serve you during the coming year. It is important that you take advantage of the opportunity to set a course for the organization in the future. Of course, if you would care to volunteer for any position, we will be glad to have your help. Keeping our Guild going is a time consuming task, and believe me, all help will be appreciated. Contact Terry or any Board member if you can spend some time for the benefit of the membership.

In closing, I wish all of you a very Happy and Prosperous New Year, and hope that 2000 will bring you and your family all of the best.

PPFA & EPFG (PART 2 OF 3)

BY EPFG BOARD

(Continued from the December 1999 EPFG Newsletter)

Throughout 1997, 1998, and 1999, PPFA has focused on rebuilding itself. Some goals were to restore faith in PPFA. PPFA has adopted an open book policy about its finances and make the financial statements readily available. The organization pledged to pay the chapters back in full for all moneys owed them, as well as keeping the payments to the chapters current. Board members were asked to be responsible to a specific number of chapters, keeping the lines of communication open to chapter needs. Increasing chapter benefits is a continuing goal, with PPFA trying to become more of a resource for chapters.

Currently, PPFA has about 4,000 members. 92% are retailers, 8% are suppliers, individuals who are not retailers, and institutions such as museums. 90% of the members are in the US, 5% are Canadian, and 5% are International. Past membership numbers are sketchy. In 1990, PPFA indicated there were about 5,000 members. In 1992, PPFA announced at the chapter leaders meeting that membership had grown to 3,800. In 1993, the executive director said there was about 7,000. In 1997, membership was thought to be less than 2,500. Growing membership so that the association can become stronger and more beneficial to the members is a goal of the board and staff. Julie feels that PPFA has the potential to attract 17,000 members.

(Continued on page 3)



January 2000

Newsletter Cost: free to EPFG members, \$1.00 for non-members

Serving Alaska & Washington

PLAN TO SPENT 2000 WITH EPFG

JANUARY 11th—
Meeting at Hartung Glass

FEBRUARY 8th—
Meeting at Lake City Picture Framing

MARCH 19th—
EPFG Annual Education Festival

APRIL 11th—
Meeting at Museum Quality Framing

A big "Thank You" to Hartung Glass for hosting the first meeting of the new millenium!.

Contact Terry Scidmore (206.433.1145) to sign up to host a meeting. Check the calendar on the back to find an open date.



HOW TO CONTACT US

Membership Dues, Advertising Payments:

Kioski Toda, EPFG Treasurer
3058 Issaquah-Pine Lake Road
Issaquah, WA 98027
Phone: (425) 557.5494

Change of Address:

Nancy Chapman
15209 263 Ave. SE
Issaquah, WA 98027
Phone: (425) 392.7334
biminidesigns@hotmail.com

For changes of address please include old and new address information.

Classified Ad Copy, Display Ad Artwork:

Tim Taricco
P.O. Box 411
Redmond, WA 98073
Fax: (630) 839-4591
frameguy@myframeshop.com

Classified ads
Free for EPFG members, \$10 for non-members

Display Ad Artwork
Digital artwork is requested. PC format preferred / Mac format okay. Submit via e-mail or on disk.

Publishing Deadline
20th of the month prior to distribution.

1999 EPFG Officers

President

Paul Knoop, CPF
the framemakers
253.564.2320
pknoop@earthlink.net

Vice President

Donna Rickman, CPF
Finishing Touches
425.338.0932
rickman@aol.com

Treasurer

Kiyoshi Toda, CPF
Accent On Framing
425.557.5494

Secretary

Terry Scidmore, CPF
The Mitered Corner
206.433.1145

Board Of Directors

Joe Garitone, CPF
Larson-Juhl
800.223.0307 x455

Joe Huber
Studio Moulding
800.262.4174 x217

Ben Edwards
Framers' Inventory
206.793.0613

Ray Miles
National Glass
800.521.7061

Past President

Frank Larson, CPF
Larson Fine Art Services
425.482.0549

The EPFG Newsletter is published monthly by Tim Taricco.
Mailing Address: P. O. Box 411 - Redmond, Washington 98073-0411. **Phone:** (206)235-8467 **Fax:** (630)839-4591
E-mail: frameguy@myframeshop.com **Web Site:** http://www.myframeshop.com. Newsletter Design ©1999 T. M. Taricco and Newsletter Content ©1999 Evergreen Picture Framers Guild. All rights reserved. Do not duplicate or redistribute in any form.

Need Training for New Employees?

**SEE WHAT YOUR DOLLAR
CAN DO IN CANADA**

**The Canadian Picture
Framer's School**

#1, 20678 Duncan Way
Langley, B.C.

providing excellent thorough
instruction in picture framing for
over 10 years. Phone or fax
for more info:

Ph: 604-533-5328
Fax: 604-533-9680

**VICTOR
MOULDING CO.**

Have you received your **VICTOR
VALUE** and **Avalon** samples yet?
Call your sales rep today for these
two exciting moulding lines that are
sure to enhance your selection.

Chuck Bigford
1-800-359-2829 ext.3715

3439 S.W. Bond
Portland, OR 97201

1-800-366-2810



You are invited to attend The West Coast Art & Frame Show & Conference

Over 235 booths, 46 Classes and workshops
Call for your free registration and information packet

800-969-7176 ext.256

WEST COAST
ART & FRAME SHOW
& CONFERENCE

January 9-12, 2000 · Bally's Las Vegas

PPFA & EPFG (CONTINUED)

(Continued from page 1)

Dues were increased in 1997 from \$125 to \$180. Member services cost \$120.53. An additional \$25 is returned to existing chapters on a quarterly basis, or deposited in the chapter development fund if there is not a chapter in the members area. \$34.47 is used for debt reduction and seed money for future programs. Member services costs consist of:

- Education: Framer's Palette, planning, registration, certification—\$13.72
- Technical Assistance: Hot Line, materials and training, staff specialties—\$11.52
- Communication: planning, Who's Who, Framing Accents, For Members Only printing and postage—\$13.17
- Chapters: Liaison, Leaders Newsletter—\$4.68
- Member Services: coordinator, retention, administrative assistant, mail room, new member kits, membership decals—\$24.53
- Headquarters: reception, copier, mailing, equipment, stationary, postage, overhead—\$52.91

Individual member services currently offered by PPFA are: PPFA Bookstore (55 print selections, 8 video selections, consumer marketing materials, 1 software program for frame shops, and 4 novelty items), monthly newsletter, members only help line, resource and membership directory, online exchange (technical information, ongoing articles from industry experts, downloadable marketing materials, and an area aimed at consumers), educational opportunities at trade shows, national framing competition, local chapter connection, certification program (also five yearly scholarships), and business programs (business insurance, discount overnight mailing, check verification, workers comp insurance, bank card processing, health and dental insurance, retirement planning, long-distance phone service, supplemental health insurance). State laws governing insurance programs vary for state to state, so not all insurance programs are available in every state. Washington state, for instance, will not let a business carry worker's comp insurance with any insurance carrier other than Washington state. As with any insurance company, the larger the member pool, the more member benefits and the more competitive the rates.

(Continued on page 5)



4

EVERGREEN PICTURE FRAMERS GUILD

Florentina™

A collection of beautiful oxidized colors inspired from the natural earth elements of Florence. The latest addition to the Larson-Juhl Classic Collection.

*For more information on Florentina and other Larson-Juhl framing products call:
(800) 438-5031*

*or contact your Larson-Juhl sales representative
Voice Mail: 800-223-0307*

Stephen Dean - ext. 454 • Joe Garitone - ext. 455 • Paul Anderson - ext. 456

LARSON · JUHL

CUSTOM FRAME THE BEAUTY OF YOUR HOME

NATIONAL GLASS

17030 WOODINVILLE-REDMOND ROAD, WOODINVILLE, WA. 98072

QUALITY PRODUCTS AND EXCELLENT SERVICE! NATIONAL GLASS INVENTORIES THE LARGEST SELECTION OF PICTURE FRAMING GLASS IN THE PACIFIC NORTHWEST.



NATIONAL GLASS

TRU VUE AND SANDEL PREMIUM, REFLECTION CONTROL, SATINVIEW, CONSERVATION SERIES GLASS, IMAGE PERFECT, DENGLAS, AND CRYSTALVIEW.

Now Available - AR Glass & Museum Glass!

ALSO AVAILABLE: FOAM-X, MIRROR AND ACRYLICS

EVERYTHING YOU NEED AND FREE DELIVERY ARE ONLY A PHONE CALL AWAY!

(425) 488-8126

1 (800) 521-7061

fax (425) 488-3712



Jeff Schuffman
Sales Representative

1433 W. Frankford Rd. #100 Carrollton, Texas 75007
972-466-0721 • 972-466-3662 Fax
800-527-0421 • 800-817-0524 Fax
Ext. 882



2928 4th Ave S • Seattle, WA 98134
Wholesale Picture Frame Supplies
206-292-9664
800-423-6287

Software Suite for all Versions of Windows
Galleries & Frame Shops Networking User Friendly!

FERENSOFT
TRiO!

- Art
- Customers
- Framing

Point of Sale and Business Management Software. *Y2K Ready!* See why people are switching to **FS TriO!** Seattle 206-282-1775
www.ferensoft.com



Edgar Solares
Account Representative
Telephone • 206-440-1545

9415 Telfair Avenue • Sun Valley CA 91352
Telephone • 818-767-8700 • 800-668-3627

TRU VUE GLASS
FOR EVERY FRAMING NEED

<p>PREMIUM SERIES GLASS</p> <ul style="list-style-type: none"> • PREMIUM CLEAR™ • REFLECTION CONTROL™ • AK™ REFLECTION FREE 	<p>CONSERVATION SERIES GLASS</p> <ul style="list-style-type: none"> • CONSERVATION CLEAR™ • CONSERVATION REFLECTION CONTROL™ • MUSEUM GLASS™
---	--

CALL TODAY! 800-282-1775
WWW.FERENSOFT.COM

PPFA & EPFG CONT.

(Continued from page 3)

Chapter services are still being developed and improved on. Currently, services include the chapter leaders manual, chapter leader's online forum, newsletter articles for chapter newsletters to borrow and share, bulk mailing of newsletters and other chapter materials, chapter leaders meetings (PPFA does underwrite some of the cost of attending this), program materials and support, and access to big name speakers in cooperation with the vendor network and trade publications. The last 2 items currently require some outlay of money from the chapter. Julie sees the chapters as a way of building cooperative relationships and a means of networking with others.

PPFA requires that board members be PPFA members. Non PPFA members may be invited to attend chapter events at higher prices than PPFA members pay. Chapters must hold a framing competition and a CPF exam annually for chapter members. Chapters must meet a minimum of 3 times per year. Chapters must have a regularly published newsletter or some

(Continued on page 9)

Fabric & Liners

The Softer Side of Framing

Hundreds of colors and textures --- Exclusive pH Neutral Fabrics



Fabrics for Framers

Dial Toll-Free (888) F.FABRIX (332-2749)



FRAMERS' INVENTORY

NOW OPEN IN SEATTLE!

WOOD MOULDING

Arquati, Bay, Framers' Inventory,
LaMarche, Max, Roma, Williamson

METAL MOULDING

Nielsen

MATBOARD

Bainbridge, Crescent, Tru Vue

GLASS & FOAMBOARD

Tru'Vue, Sandel,
Bienfang, Bainbridge

EQUIPMENT

C&H, Fletcher
Seal Mounting

SERVICE

Daily delivery in the
Portland & Seattle Metro areas
Will call open til 6:00 PM
Overnight chop service



4412 4TH AVENUE SOUTH, SEATTLE WA 98143
5000 SE 18TH AVENUE, PORTLAND, OREGON 97202
TOLL FREE(800)543-2467 FAX(503)238-3899

STUDIO MOULDING

8214-B South 192nd St., Kent, WA 98032

FREE FREIGHT

On all orders over \$100.00 in OR and WA

JOE HUBER

Orders: (800) 262-4174

Voice Mail Ext: 217

Fax: (888) 423-1814



CORONA

1150 Industry Drive Tukwila, WA 98188
Division of RCI, Inc.



The choice of professionals, CORONA Cold & Hot/Cold Vacuum presses. Complete mounting/laminating supplies. Originators of BERTO and Corona Hot/Cold Unimount adhesives. the industry mainstays for over 20 years. 'The Mounting Specialists'.

Suppliers to the Picture Framing Industry for over
30 years

206.575.2727 Fax: 206.575.2667

HARTUNG GLASS INDUSTRIES

Hartung Glass was the first company in the Northwest Region to deliver to the Picture Framing Industry. We have been serving the Picture Framers in our area for over twenty years and offer the largest inventory of stock sheets in the Pacific Northwest. We feature all of the top manufacturers, including Sandel, Tru-Vue, and Cyro, with scheduled deliveries to most areas of Washington. We carry many types of framing glass, including:

Clear	Sandel Superior
Anti-Reflection	Sandel Crystalview
Non-Glare	Tru-Vue & Sandel
Conservation	Tru-Vue
Preservation	Sandel
Museum Glass	Tru-Vue

Call today to schedule a delivery!

***Hartung now stocks
3/16 mirror with 1"
bevel for framing.
Call our helpful cus-
tomer Service De-
partment today to
place your order!***

425/656-2626

800/551-2227



6001 Santa Monica Boulevard, Los Angeles, California 90038
 Tel # (213) 469-9006 • Fax # (213) 469-0940
 World Wide Web: <http://www.FramingFabrics.com> • E-mail: info@ffmi.com

New Pre-Covered Lip Liner

Ask about our
 Distributors Discount.

Expanded Liner Selection

Framing Fabrics & Moulding International

is very happy to introduce NEW LINERS. With the recent expansion of our liner offerings, we are able to provide our customers with a complete liner selection, at very competitive prices. These seven new additions include a flat profile in two sizes, a bevel profile in two sizes and a scoop profile in three sizes, all with hand-finished lips of bright gold, antique gold and antique silver. These lip liners are available in four fabrics, 100% BELGIQUE Natural Linen; Union Blend of MANHASSET Natural and Oyster and Antique Satin MARQUIS Black.

LIP FINISHES

Bright Gold ❖ Antique Gold ❖ Antique Silver

FABRICS

Manhasset Natural ❖ Manhasset Oyster
 Belgique Natural ❖ Marquis Black

All are pre-covered. However, we are also able to meet most of your custom needs (*Custom Wraps*), just call and ask our Customer Service Department personnel. Upon request, we can cover our lip liners with any of the 500 fabrics we sell. A 50 ft. minimum applies to liners cut to 6 & 4 or 5 & 5 ft. lengths; a 100 ft. is required on liners in standard 10 ft. lengths.

These liners are in addition to the original thirty liner profiles we offer in Primed, Pre-covered and *Custom Wrapped* both in length and chop.

FLAT

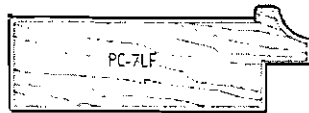
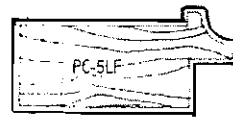

BEVEL

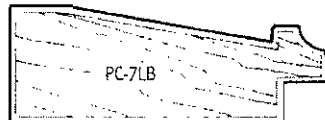

SCOOP

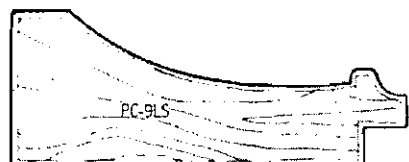
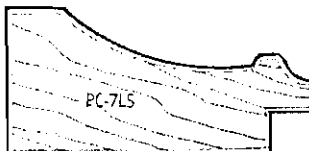
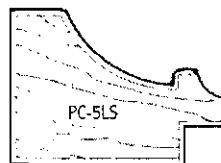

Shown Actual Size



Chances are you started out with a LOGAN Mat Cutter Have you seen what we've done lately?

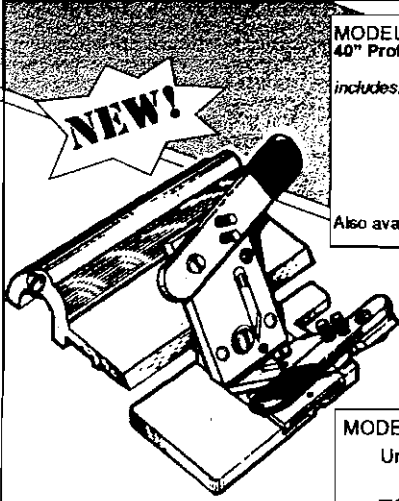

Model 705
Logan
V-Groover

MODEL #650 *Framer's Edge* MAT CUTTER 40" Professional Production Matcutter

- includes:
- Ergonomically designed Dual straight and Bevel cutting head
 - Production Stops
 - Parallel Mat Guide
 - Start and Stop Indicator for line to line cutting.
 - 27" Squaring Arm

Suggested List Price \$599.95

Also available in a 60" version MODEL #660 *Framer's Edge* \$799.95

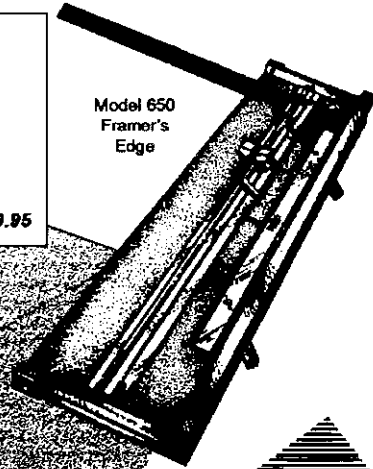

Model 650
Framer's
Edge

MODEL 705 LOGAN V-Groover patented

Unique "push-pull" surface V-Groover that cuts beautiful V-Grooves on the surface of the matboard. Works entirely with stops provided for accurate V-Grooving in seconds with zero overcuts. Endless creative possibilities!!

Suggested List Price \$125.00

MODEL 706 Universal V-Groover patented

Works on professional mat cutters using a 5/8" thick cutting bar rod including Fletcher® and C&H® professional matcutters.

Suggested List Price \$150.00



GRAPHIC PRODUCTS, INC.

1100 BROWN STREET • WALUCONDA, ILLINOIS 60084
NATIONWIDE TOLL FREE 1-800/331-6222
TOLL FREE FAX 800/331-6329

See us at <http://www.artproducts.com>

E-MAIL: Logan-Graphic-Products@worldnet.att.net

SEATTLE, WA 98133



THE ART DOCTOR

Restoration of Oil Paintings, Japanese Screens,
Art on Paper, Art Objects

NANCY G. WHITE
Restorer

(206) 783-9160
By Appointment



Pacific Framing Supply

"Serving all of your framing needs"

Brad Airhart & John Cave

Salem, OR 97304
Phone: 1-800-872-4445
FAX: 1-503-363-7273

Woodinville, WA 98072
Phone: 1-800-292-3202
FAX: 1-206-486-4978

WILLIAMSON • FOAMCORE • TRUVUE GLASS/MILLER MATBOARD
CLARK • DESIGNER WOOD & METAL • COLONIAL • BURNICH

TruVue Beveled Mirrors

TruVue's 1-1/4" Beveled Mirrors are the highest quality available.

Featuring a scratch-resistant front surface coating, they are thermally cured and have a double layer back coating. In addition, TruVue Mirrors come with a seven-year limited warranty.

MFA carries the following sizes:

20x24, 22x28, 24x24, 24x36, 32x40 and 36x48. Call for more details!

METAL FRAMES ART



6010 EAST ALKI WAREHOUSE #5
PHONE 800 344-7329 509 535-3440

SPOKANE WASHINGTON 99212
FAX 800 344-5003 509 535-3466

It's About Choices...



Crescent Regular Matboard, with the greatest array of colors, is the **right choice** for everyday decorative

framing. Crescent Whitecore Basics, with its non-yellowing white core, is the **ideal choice** for the

design requirements of today's contemporary decor. Crescent Rug Mat remains the **only choice** for conservation framing.

With its naturally 100% acid- and lignin-free cream core, **Whitecore** is the premier choice for preserving priceless works

of art and irreplaceable memories.



Crescent

WE GIVE YOU THE RIGHT CHOICE!
<http://www.crescent-cardboard.com>

Crescent Cardboard Company, 100 West Willow Road, Wheeling, Illinois 60090, Tel. 1-847-537-3400, Fax 1-847-537-7153



PPFA & EPFG (CONT.)

(Continued from page 5)

other form of communication with its members. Chapters must submit timely minutes of meetings to PPFA National. Each January, chapters must submit an annual chapter status report and financial report to PPFA National on specific PPFA forms.

Julie sees the chapters as a way of building cooperative relationships, networking with others and developing leadership skills. She emphasizes that there is strength in numbers. A larger membership provides a better bargaining position for services such as insurance and bank card rates. Ultimately, the chapters serve as the voice of the membership, helping PPFA to shape the programs and services it offers.

Julie admitted that the past boards of PPFA made some bad mistakes. She feels that there is no way the past can be changed. It is more important to acknowledge that mistakes were made, learn from them, and move forward.

Look for the February EPFG newsletter to read the conclusion of this article.

NURRE CAXTON

FRAMES OF DISTINCTION



*"We're Obsessed
With Customer
Satisfaction"*

Pamela Neal

Sales Representative for
Washington, Wyoming, Montana
Oregon and Idaho

1-800-255-1942, press 6, ext. 4011
for voice mail
1-800-377-3300 fax
1-800-910-8966 pager

We promise friendly, reliable service.
same day chop service, free UPS
for orders of 3 chops or more
(wood and Nielsen metal combined)

MEMBERSHIP APPLICATION & UPDATE FORM

Company Name:

Phone:

Contact Name:

Fax:

Street Address:

E-Mail:

City:

Web Site: <http://>

State:

Zip:

Complete this form and return it with your membership dues of \$40.

Mail to: Kiyoshi Toda, CPF— Accent On Framing, 3058 Issaquah-Pine Lake Rd Se, Issaquah, WA 98027

For more Information about the Evergreen Picture Framers Guild, please contact: Nancy Chapman, 15209 263 Ave. SE, Issaquah, WA 98027. Phone: (425) 392.7334. E-mail: biminidesigns@hotmail.com

<p>January 2000</p> <p>11th – General Meeting – 7 PM <i>Hartung Glass—Tukwila</i></p> <p>9th -12th—West Coast Art & Frame Show—Las Vegas</p>	<p>February 2000</p> <p>8th – General Meeting – 7 PM <i>Lake City Picture Framing—Seattle</i></p>	<p>March 2000</p> <p>19th – EPFG Education Festival</p>	<p>April 2000</p> <p>11th – General Meeting – 7 PM <i>Museum Quality Framing</i></p>
<p>May 2000</p> <p>9th – General Meeting – 7 PM</p>	<p>June 2000</p> <p>13th – General Meeting – 7 PM</p>	<p>July 2000</p> <p>11th – General Meeting – 7 PM</p>	<p>August 2000</p> <p>EPFG Annual Picnic</p>
<p>September 2000</p> <p>12th – General Meeting – 7 PM</p>	<p>October 2000</p> <p>10th – General Meeting – 7 PM</p>	<p>November 2000</p> <p>14th – General Meeting – 7 PM <i>Colorplak—Redmond</i></p>	<p>December 2000</p> <p>No Meeting</p>



T. M. Taricco
P. O. Box 411
Redmond, Washington 98073-0411

SEE PAGE TWO OF THIS
NEWSLETTER FOR ADDRESS
CHANGE CONTACT INFORMATION

IF YOUR MAILING LABEL IS WHITE, YOUR
EPFG MEMBERSHIP DUES ARE PAST DUE.
PLEASE COMPLETE THE FORM ON PAGE 9
TO BRING YOUR MEMBERSHIP CURRENT.

ATTENTION: FRAME SHOP